

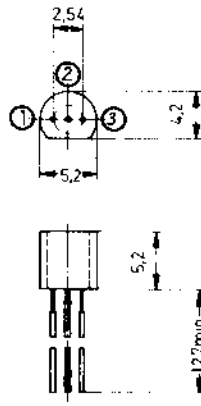

SOLUTIONS FOR THE ELECTRONICS INTERCONNECTION PROCESS

AV. GRAL. RONDEAU 1534
Tel.: 598-2-902 3010
Fax: 598-2-902 1173
eneka@adinet.com.uy



D9 (TO-92/SOT-30)

TYP-CODE

Bei Miniaturtypen muß oft aus Platzgründen die Typenbezeichnung verkürzt (codiert) aufgestempelt werden. Dieser Typ-Code ist jeweils in der Spalte »Anwendung« zu finden. Ist jedoch die Typenbezeichnung unbekannt, dient nachstehende alphabetische Auflistung aller Typ-Codes zum Auffinden der vollständigen Bezeichnung und damit der Daten etc.

On miniaturized types the type identification often has to be printed abbreviated (coded) due to lack of space. This type code can be found in the "Application" column in each case. If type identification is not known, however, the following alphabetical list of all type codes assists locating the full designation and thus the data etc.

Pour les types miniature, les cachets utilisés donnent souvent des abréviations pour les désignations de type (codification). Ce code-type apparaîtra toujours dans la colonne «application». Si jamais la désignation de type reste inconnue, la liste alphabétique ci-jointe indiquera la désignation complète et par conséquent, les données, etc.

Per ragione di spazio, con tipi in miniatura la designazione del tipo dev' essere stampigliato spesso in forma abbreviata (codificata). Questo codice-tipo si trova sempre nella colonna «applicazione». Qualora la designazione del tipo non è conosciuta, serve la seguente elencazione alfabetica di tutti i codici-tipo per ritrovare la denominazione completa e con ciò i dati, ecc.

En los modelos miniaturizados puede resultar preciso abreviar el código de modelo impreso en la cápsula. Este código puede encontrarse en la columna «Aplicación». De no conocerse la denominación completa del modelo puede consultarse la siguiente lista alfabética para determinar la denominación exacta y con ella los datos característicos, etc.

Code	Herst.	Typ	Art	Fig.	Code	Herst.	Typ	Art	Fig.	Code	Herst.	Typ	Art	Fig.
J111	Phi	BSJ111	FET	D9	GL	Tho	SM6T150A	Z-Di.	D42	RQ	Tho	SM4T30	Z-Di.	D42
J112	Phi	BSJ112	FET	D9	GT	Tho	SM6T200	Z-Di.	D42	RR	Tho	SM4T30A	Z-Di.	D42
J113	Phi	BSJ113	FET	D9	GU	Tho	SM6T200A	Z-Di.	D42	RS	Tho	SM4T33	Z-Di.	D42
M11	Mit	MC911	Diode	D6	GV	Tho	SM6T220	Z-Di.	D42	RT	Tho	SM4T33A	Z-Di.	D42
M21	Mit	MC921	Diode	D6	GW	Tho	SM6T220A	Z-Di.	D42	RJ	Tho	SM4T36	Z-Di.	D42
M31	Mit	MC931	Diode	D6	LD	Tho	SM6T6V8C	Z-Di.	D42	RV	Tho	SM4T36A	Z-Di.	D42
M32	Mit	MC932	Diode	D6	LE	Tho	SM6T6V8CA	Z-Di.	D42	RW	Tho	SM4T39	Z-Di.	D42
					LF	Tho	SM6T7V5C	Z-Di.	D42	RX	Tho	SM4T39A	Z-Di.	D42
					LG	Tho	SM6T7V5CA	Z-Di.	D42	SN	Tho	SM4T68	Z-Di.	D42
					LN	Tho	SM6T10C	Z-Di.	D42	SP	Tho	SM4T68A	Z-Di.	D42
					LP	Tho	SM6T10CA	Z-Di.	D42	SW	Tho	SM4T100	Z-Di.	D42
					LW	Tho	SM6T15C	Z-Di.	D42	SX	Tho	SM4T100A	Z-Di.	D42
					LX	Tho	SM6T15CA	Z-Di.	D42	TH	Tho	SM4T150	Z-Di.	D42
					MD	Tho	SM6T18C	Z-Di.	D42	TK	Tho	SM4T150A	Z-Di.	D42
					ME	Tho	SM6T18CA	Z-Di.	D42	TS	Tho	SM4T200	Z-Di.	D42
					MH	Tho	SM6T22C	Z-Di.	D42	TT	Tho	SM4T200A	Z-Di.	D42
					MK	Tho	SM6T22CA	Z-Di.	D42	TU	Tho	SM4T220	Z-Di.	D42
					ML	Tho	SM6T24C	Z-Di.	D42	TV	Tho	SM4T220A	Z-Di.	D42
					MM	Tho	SM6T24CA	Z-Di.	D42	UD	Tho	SM4T18C	Z-Di.	D42
					MN	Tho	SM6T27C	Z-Di.	D42	UE	Tho	SM4T18CA	Z-Di.	D42
					MP	Tho	SM6T27CA	Z-Di.	D42	UH	Tho	SM4T22C	Z-Di.	D42
					MQ	Tho	SM6T30C	Z-Di.	D42	UK	Tho	SM4T22CA	Z-Di.	D42
					MR	Tho	SM6T30CA	Z-Di.	D42	UL	Tho	SM4T24C	Z-Di.	D42
					MS	Tho	SM6T33C	Z-Di.	D42	UM	Tho	SM4T24CA	Z-Di.	D42
					MT	Tho	SM6T33CA	Z-Di.	D42	UN	Tho	SM4T27C	Z-Di.	D42
					MU	Tho	SM6T36C	Z-Di.	D42	UP	Tho	SM4T27CA	Z-Di.	D42
					MV	Tho	SM6T36CA	Z-Di.	D42	UQ	Tho	SM4T30C	Z-Di.	D42
					MW	Tho	SM6T39C	Z-Di.	D42	UR	Tho	SM4T30CA	Z-Di.	D42
					MX	Tho	SM6T39CA	Z-Di.	D42	US	Tho	SM4T33C	Z-Di.	D42
					NP	Tho	SM6T68C	Z-Di.	D42	UT	Tho	SM4T33CA	Z-Di.	D42
					NO	Tho	SM6T68CA	Z-Di.	D42	UJ	Tho	SM4T36C	Z-Di.	D42
					NX	Tho	SM6T100C	Z-Di.	D42	UV	Tho	SM4T36CA	Z-Di.	D42
					NY	Tho	SM6T100CA	Z-Di.	D42	UW	Tho	SM4T39C	Z-Di.	D42
					OK	Tho	SM6T150C	Z-Di.	D42	UX	Tho	SM4T39CA	Z-Di.	D42
					OL	Tho	SM6T150CA	Z-Di.	D42	VD	Tho	SM4T6V8C	Z-Di.	D42
					OT	Tho	SM6T200C	Z-Di.	D42	VE	Tho	SM4T6V8CA	Z-Di.	D42
					OU	Tho	SM6T200CA	Z-Di.	D42	VF	Tho	SM4T7V5C	Z-Di.	D42
					OD	Tho	SM4T6V8	Z-Di.	D42	VG	Tho	SM4T7V5CA	Z-Di.	D42
					OE	Tho	SM4T6V8A	Z-Di.	D42	VN	Tho	SM4T10C	Z-Di.	D42
					OF	Tho	SM4T7V5	Z-Di.	D42	VP	Tho	SM4T10CA	Z-Di.	D42
					OG	Tho	SM4T7V5A	Z-Di.	D42	VS	Tho	SM4T12C	Z-Di.	D42
					QN	Tho	SM4T10	Z-Di.	D42	VT	Tho	SM4T12CA	Z-Di.	D42
					QP	Tho	SM4T10A	Z-Di.	D42	WW	Tho	SM4T15C	Z-Di.	D42
					QS	Tho	SM4T12	Z-Di.	D42	VX	Tho	SM4T15CA	Z-Di.	D42
					QT	Tho	SM4T12A	Z-Di.	D42	WN	Tho	SM4T68C	Z-Di.	D42
					QW	Tho	SM4T15	Z-Di.	D42	WP	Tho	SM4T68CA	Z-Di.	D42
					QX	Tho	SM4T15A	Z-Di.	D42	WW	Tho	SM4T100C	Z-Di.	D42
					RD	Tho	SM4T18	Z-Di.	D42	WX	Tho	SM4T100CA	Z-Di.	D42
					RE	Tho	SM4T18A	Z-Di.	D42	XH	Tho	SM4T150C	Z-Di.	D42
					RH	Tho	SM4T22	Z-Di.	D42	XK	Tho	SM4T150CA	Z-Di.	D42
					RK	Tho	SM4T22A	Z-Di.	D42	XS	Tho	SM4T200C	Z-Di.	D42
					RL	Tho	SM4T24	Z-Di.	D42	XT	Tho	SM4T200CA	Z-Di.	D42
					RM	Tho	SM4T24A	Z-Di.	D42					
					RN	Tho	SM4T27	Z-Di.	D42					
					RP	Tho	SM4T27A	Z-Di.	D42					

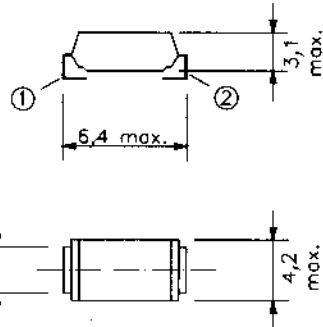

D42/SOD-6

Code	Herst.	Typ	Art	Fig.	Code	Herst.	Typ	Art	Fig.	Code	Herst.	Typ	Art	Fig.
------	--------	-----	-----	------	------	--------	-----	-----	------	------	--------	-----	-----	------

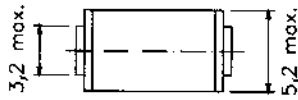
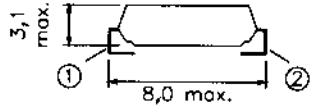

D48/SOD-15

BDD	Tho	SM15T6V8C	Z-Di.	D48
BDE	Tho	SM15T6V8CA	Z-Di.	D48
BDF	Tho	SM15T7V5C	Z-Di.	D48
BDG	Tho	SM15T7V5CA	Z-Di.	D48
BDN	Tho	SM15T10C	Z-Di.	D48
BDP	Tho	SM15T10CA	Z-Di.	D48
BDS	Tho	SM15T12C	Z-Di.	D48
BDT	Tho	SM15T12CA	Z-Di.	D48
BDW	Tho	SM15T15C	Z-Di.	D48
BDX	Tho	SM15T15CA	Z-Di.	D48
BED	Tho	SM15T18C	Z-Di.	D48
BEE	Tho	SM15T18CA	Z-Di.	D48
BEH	Tho	SM15T22C	Z-Di.	D48
BEK	Tho	SM15T22CA	Z-Di.	D48
BEL	Tho	SM15T24C	Z-Di.	D48
BEM	Tho	SM15T24CA	Z-Di.	D48
BEN	Tho	SM15T27C	Z-Di.	D48
BEP	Tho	SM15T27CA	Z-Di.	D48
BEQ	Tho	SM15T30C	Z-Di.	D48
BER	Tho	SM15T30CA	Z-Di.	D48
BES	Tho	SM15T33C	Z-Di.	D48
BET	Tho	SM15T33CA	Z-Di.	D48
BEU	Tho	SM15T36C	Z-Di.	D48
BEV	Tho	SM15T36CA	Z-Di.	D48
BEW	Tho	SM15T39C	Z-Di.	D48
BEX	Tho	SM15T39CA	Z-Di.	D48
BFN	Tho	SM15T68C	Z-Di.	D48
BFP	Tho	SM15T68CA	Z-Di.	D48
BFW	Tho	SM15T100C	Z-Di.	D48
BFX	Tho	SM15T100CA	Z-Di.	D48
BGH	Tho	SM15T150C	Z-Di.	D48
BGK	Tho	SM15T150CA	Z-Di.	D48
BGU	Tho	SM15T200C	Z-Di.	D48
BGV	Tho	SM15T200CA	Z-Di.	D48
MDD	Tho	SM15T6V8	Z-Di.	D48
MDE	Tho	SM15T6V8A	Z-Di.	D48
MDF	Tho	SM15T7V5	Z-Di.	D48
MDG	Tho	SM15T7V5A	Z-Di.	D48
MDN	Tho	SM15T10	Z-Di.	D48
MDP	Tho	SM15T10A	Z-Di.	D48
MDS	Tho	SM15T12	Z-Di.	D48
MDT	Tho	SM15T12A	Z-Di.	D48
MDW	Tho	SM15T15	Z-Di.	D48
MDX	Tho	SM15T15A	Z-Di.	D48
MED	Tho	SM15T18	Z-Di.	D48
MEE	Tho	SM15T18A	Z-Di.	D48
MEH	Tho	SM15T22	Z-Di.	D48
MEK	Tho	SM15T22A	Z-Di.	D48
MEL	Tho	SM15T24	Z-Di.	D48
MEM	Tho	SM15T24A	Z-Di.	D48
MEN	Tho	SM15T27	Z-Di.	D48
MEP	Tho	SM15T27A	Z-Di.	D48
MEQ	Tho	SM15T30	Z-Di.	D48
MER	Tho	SM15T30A	Z-Di.	D48
MES	Tho	SM15T33	Z-Di.	D48
MET	Tho	SM15T33A	Z-Di.	D48
MEU	Tho	SM15T36	Z-Di.	D48
MEV	Tho	SM15T36A	Z-Di.	D48
MEW	Tho	SM15T39	Z-Di.	D48

MEX	Tho	SM15T39A	Z-Di.	D48
MFN	Tho	SM15T68	Z-Di.	D48
MFV	Tho	SM15T68A	Z-Di.	D48
MFW	Tho	SM15T100	Z-Di.	D48
MFX	Tho	SM15T100A	Z-Di.	D48
MGH	Tho	SM15T150	Z-Di.	D48
MGK	Tho	SM15T150A	Z-Di.	D48
MGU	Tho	SM15T200	Z-Di.	D48
MGV	Tho	SM15T200A	Z-Di.	D48
MGW	Tho	SM15T220	Z-Di.	D48
MGX	Tho	SM15T220A	Z-Di.	D48
ZDD	Tho	SM5Z3V3A	Z-Di.	D48
ZDE	Tho	SM5Z3V6A	Z-Di.	D48
ZDF	Tho	SM5Z3V9A	Z-Di.	D48
ZDG	Tho	SM5Z4V3A	Z-Di.	D48
ZDH	Tho	SM5Z4V7A	Z-Di.	D48
ZDK	Tho	SM5Z5V1A	Z-Di.	D48
ZDL	Tho	SM5Z5V6A	Z-Di.	D48
ZDN	Tho	SM5Z6V2A	Z-Di.	D48
ZDP	Tho	SM5Z6V8A	Z-Di.	D48
ZDQ	Tho	SM5Z7V5A	Z-Di.	D48
ZDR	Tho	SM5Z8V2A	Z-Di.	D48
ZDT	Tho	SM5Z9V1A	Z-Di.	D48
ZDU	Tho	SM5Z10A	Z-Di.	D48
ZDW	Tho	SM5Z12A	Z-Di.	D48
ZDX	Tho	SM5Z13A	Z-Di.	D48
ZDY	Tho	SM5Z14A	Z-Di.	D48
ZDZ	Tho	SM5Z15A	Z-Di.	D48
ZED	Tho	SM5Z16A	Z-Di.	D48
ZEF	Tho	SM5Z18A	Z-Di.	D48
ZEH	Tho	SM5Z20A	Z-Di.	D48
ZEK	Tho	SM5Z22A	Z-Di.	D48
ZEL	Tho	SM5Z24A	Z-Di.	D48
ZEN	Tho	SM5Z27A	Z-Di.	D48
ZEP	Tho	SM5Z28A	Z-Di.	D48
ZEQ	Tho	SM5Z30A	Z-Di.	D48
ZER	Tho	SM5Z33A	Z-Di.	D48
ZET	Tho	SM5Z39A	Z-Di.	D48
ZEZ	Tho	SM5Z47A	Z-Di.	D48
ZFD	Tho	SM5Z62A	Z-Di.	D48
ZFG	Tho	SM5Z82A	Z-Di.	D48
ZFK	Tho	SM5Z91A	Z-Di.	D48
ZFL	Tho	SM5Z100A	Z-Di.	D48
ZFM	Tho	SM5Z110A	Z-Di.	D48
ZFR	Tho	SM5Z150A	Z-Di.	D48
ZFS	Tho	SM5Z160A	Z-Di.	D48
ZFU	Tho	SM5Z180A	Z-Di.	D48
ZFW	Tho	SM5Z200A	Z-Di.	D48

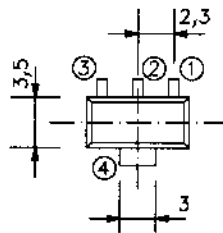

D49/SOT-223

AA	Phi	BCP 51	Trans.	D49
AC	Phi	BCP 51-10	Trans.	D49
AD	Phi	BCP 51-16	Trans.	D49
AE	Phi	BCP 52	Trans.	D49
AG	Phi	BCP 52-10	Trans.	D49
AH	Phi	BCP 53	Trans.	D49
AK	Phi	BCP 53-10	Trans.	D49
AL	Phi	BCP 53-16	Trans.	D49
AM	Phi	BCP 52-16	Trans.	D49
AR1	Phi	BSP 40	Trans.	D49
AR2	Phi	BSP 41	Trans.	D49
AR3	Phi	BSP 42	Trans.	D49

AR4	Phi	BSP 43	Trans.	D49
AS1	Phi,Sie	BSP 50	Trans.	D49
AS2	Phi,Sie	BSP 51	Trans.	D49
AS3	Phi,Sie	BSP 52	Trans.	D49
AT1	Phi	BSP 19	Trans.	D49
AT2	Phi	BSP 20	Trans.	D49
BA	Phi	BCP 54	Trans.	D49
BC	Phi	BCP 54-10	Trans.	D49
BD	Phi	BCP 54-16	Trans.	D49
BE	Phi	BCP 55	Trans.	D49
BG	Phi	BCP 55-10	Trans.	D49
BJ	Phi	BCP 56	Trans.	D49
BK	Phi	BCP 56-10	Trans.	D49
BL	Phi	BCP 56-16	Trans.	D49
BM	Phi	BCP 55-16	Trans.	D49
BR1	Phi	BSP 30	Trans.	D49
BR2	Phi	BSP 31	Trans.	D49
BR3	Phi	BSP 32	Trans.	D49
BR4	Phi	BSP 33	Trans.	D49
BS1	Phi,Sie	BSP 60	Trans.	D49
BS2	Phi,Sie	BSP 61	Trans.	D49
BS3	Phi,Sie	BSP 62	Trans.	D49
BT1	Phi	BSP 15	Trans.	D49
BT2	Phi	BSP 16	Trans.	D49
CA	Phi	BCP 68	Trans.	D49
CE	Phi	BCP 69	Trans.	D49
DA	Phi	BF 722	Trans.	D49
DB	Phi	BF 723	Trans.	D49
DC	Phi	BF 720	Trans.	D49
DF	Phi	BF 721	Trans.	D49
P1A	Phi	PZT 3904	Trans.	D49
P1D	Phi	PZTA 42	Trans.	D49
P1E	Phi	PZTA 43	Trans.	D49
P1M	Phi	PZTA 13	Trans.	D49
P1N	Phi	PZTA 14	Trans.	D49
P2A	Phi	PZT 3906	Trans.	D49
P2B	Phi	PZT 2907	Trans.	D49
P2D	Phi	PZTA 92	Trans.	D49
P2E	Phi	PZTA 93	Trans.	D49
P2F	Phi	PZT 2907A	Trans.	D49
P2U	Phi	PZTA 63	Trans.	D49
P2V	Phi	PZTA 64	Trans.	D49
ZT2222	Sie	PZT 2222	Trans.	D49
ZT2222A	Sie	PZT 2222A	Trans.	D49
ZT2907	Sie	PZT 2907	Trans.	D49
ZT2907A	Sie	PZT 2907A	Trans.	D49
ZT3904	Sie	PZT 3904	Trans.	D49
ZT3906	Sie	PZT 3906	Trans.	D49

Code Herst. Typ Art Fig.

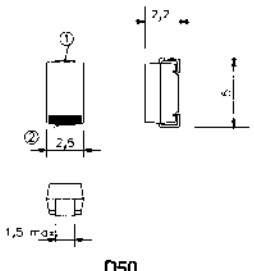

D50

Code Herst. Typ Art Fig.

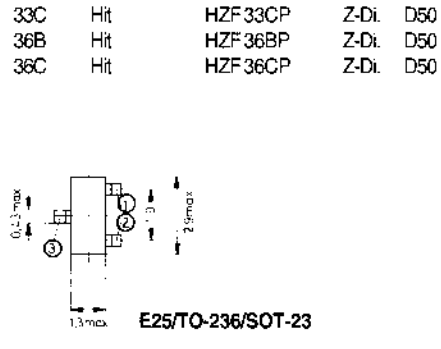

E25/TO-236/SOT-23

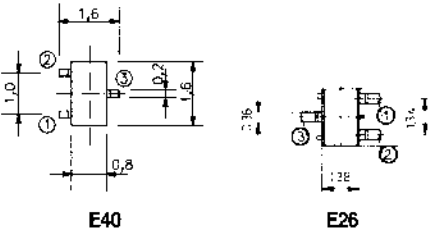

E40

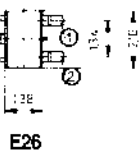

E26

PA	Mat	MA 735	Diode	D50
PB	Mat	MA 736	Diode	D50
PC	Mat	MA 737	Diode	D50
PD	Mat	MA 738	Diode	D50
PE	Mat	MA 739	Diode	D50
PH	Mat	MA 643	Diode	D50
2.0B	Hit	HZF 2.0BP	Z-Di.	D50
2.0C	Hit	HZF 2.0CP	Z-Di.	D50
2.2B	Hit	HZF 2.2BP	Z-Di.	D50
2.2C	Hit	HZF 2.2CP	Z-Di.	D50
2.4B	Hit	HZF 2.4BP	Z-Di.	D50
2.4C	Hit	HZF 2.4CP	Z-Di.	D50
2.7B	Hit	HZF 2.7BP	Z-Di.	D50
2.7C	Hit	HZF 2.7CP	Z-Di.	D50
3.0B	Hit	HZF 3.0BP	Z-Di.	D50
3.0C	Hit	HZF 3.0CP	Z-Di.	D50
3.3B	Hit	HZF 3.3BP	Z-Di.	D50
3.3C	Hit	HZF 3.3CP	Z-Di.	D50
3.6B	Hit	HZF 3.6BP	Z-Di.	D50
3.6C	Hit	HZF 3.6CP	Z-Di.	D50
3.9B	Hit	HZF 3.9BP	Z-Di.	D50
3.9C	Hit	HZF 3.9CP	Z-Di.	D50
4.3B	Hit	HZF 4.3BP	Z-Di.	D50
4.3C	Hit	HZF 4.3CP	Z-Di.	D50
4.7B	Hit	HZF 4.7BP	Z-Di.	D50
4.7C	Hit	HZF 4.7CP	Z-Di.	D50
5.1B	Hit	HZF 5.1BP	Z-Di.	D50
5.1C	Hit	HZF 5.1CP	Z-Di.	D50
5.6B	Hit	HZF 5.6BP	Z-Di.	D50
5.6C	Hit	HZF 5.6CP	Z-Di.	D50
6.2B	Hit	HZF 6.2BP	Z-Di.	D50
6.2C	Hit	HZF 6.2CP	Z-Di.	D50
6.8B	Hit	HZF 6.8BP	Z-Di.	D50
6.8C	Hit	HZF 6.8CP	Z-Di.	D50
7.5B	Hit	HZF 7.5BP	Z-Di.	D50
7.5C	Hit	HZF 7.5CP	Z-Di.	D50
8.2B	Hit	HZF 8.2BP	Z-Di.	D50
8.2C	Hit	HZF 8.2CP	Z-Di.	D50
9.1B	Hit	HZF 9.1BP	Z-Di.	D50
9.1C	Hit	HZF 9.1CP	Z-Di.	D50
10B	Hit	HZF 10BP	Z-Di.	D50
10C	Hit	HZF 10CP	Z-Di.	D50
11B	Hit	HZF 11BP	Z-Di.	D50
11C	Hit	HZF 11CP	Z-Di.	D50
12B	Hit	HZF 12BP	Z-Di.	D50
12C	Hit	HZF 12CP	Z-Di.	D50
13B	Hit	HZF 13BP	Z-Di.	D50
13C	Hit	HZF 13CP	Z-Di.	D50
15B	Hit	HZF 15BP	Z-Di.	D50
15C	Hit	HZF 15CP	Z-Di.	D50
16B	Hit	HZF 16BP	Z-Di.	D50
16C	Hit	HZF 16CP	Z-Di.	D50
18B	Hit	HZF 18BP	Z-Di.	D50
18C	Hit	HZF 18CP	Z-Di.	D50
20B	Hit	HZF 20BP	Z-Di.	D50
20C	Hit	HZF 20CP	Z-Di.	D50
22B	Hit	HZF 22BP	Z-Di.	D50
22C	Hit	HZF 22CP	Z-Di.	D50
24B	Hit	HZF 24BP	Z-Di.	D50
24C	Hit	HZF 24CP	Z-Di.	D50
27B	Hit	HZF 27BP	Z-Di.	D50
27C	Hit	HZF 27CP	Z-Di.	D50
30B	Hit	HZF 30BP	Z-Di.	D50
30C	Hit	HZF 30CP	Z-Di.	D50
33B	Hit	HZF 33BP	Z-Di.	D50

33C	Hit	HZF 33CP	Z-Di.	D50
36B	Hit	HZF 36BP	Z-Di.	D50
36C	Hit	HZF 36CP	Z-Di.	D50
A	Tos	2SC2532	Trans.	E25
A	Say	SB 01-05CP	Diode	E25
A	Say	SB 01-05Q	Diode	E26
A1(p.s)	Phi,Mot,Sie	BAW 56	Diode	E25
A1	Hit	HSM 124S	Diode	E25
A1	Say	DSE 015	Diode	E26
A2	Phi	BAT 18	Diode	E25
A2	Fer	ZC 833A	Diode	E25
A2	Phi	PMBD 2836	Diode	E25
A2	Mot	MMBD 2836	Diode	E25
A2	Hit	HSM 221C	Diode	E25
A2	Say	DSB 015	Diode	E25
A2	Say	DSH 015	Diode	E26
A3(p)	Phi,Val	BAT 17	Diode	E25
A3	Nip	1S2835	Diode	E25
A3	Fer	BAS 16	Diode	E25
A3	Phi	PMBD 2835	Diode	E25
A3	Mot	MMBD 2835	Diode	E25
A3	Tos	1SS181	Diode	E25
A3	Tos	1SS300	Diode	E26
A3	Tos	1SS360	Diode	E40
A4(p.s)	Phi,Mot,Sie	BAW 70	Diode	E25
A4	Nip	1S2836	Diode	E25
A4	Mit	MC 2836	Diode	E25
A4	Mit	MC 2846	Diode	E26
A4	Hit	HSM 2836C	Diode	E25
A4	Say	DCF 015	Diode	E26
A5(p)	Phi	BRY 61	PUT	E25
A5	Nip	1S2837	Diode	E25
A5	Phi	PMBD 2837	Diode	E25
A5	Mot	MMBD 2837	Diode	E25
A6	Nip	1S2838	Diode	E25
A6(s,p)	Mot,Sie,Phi	BAS 16	Diode	E25
A6	Phi	PMBD 2838	Diode	E25
A6	Mot	MMBD 2838	Diode	E25
A6	Mit	MC 2838	Diode	E25
A6	Mit	MC 2848	Diode	E26
A6	Hit	HSM 2838C	Diode	E25
A6	Say	DCG 015	Diode	E26
A7(p.s)	Val,Mot,Sie	BAV 99	Diode	E25
A7	Mit	MC 2840	Diode	E25
A7	Mit	MC 2850	Diode	E26
A8	Val	BAS 19	Diode	E25
A8	Hit	HSM 223C	Diode	E25
A9	Val	AAY 60	Diode	E25
A9	Tos	1SS294	Diode	E25
A9	Tos	1SS322	Diode	E26
A9	Hit	HSM 123	Diode	E25
A17	Say	2SK436-A17	FET	E25
A18	Say	2SK436-A18	FET	E25
A19	Say	2SK436-A19	FET	E25

Code Herst. Typ Art Fig.

A20	Say	2SK1066-20	FET	E26
A20	Say	2SK436-A20	FET	E25
A21	Say	2SK436-A21	FET	E25
A21	Say	2SK1066-21	FET	E26
A22	Say	2SK436-A22	FET	E25
A22	Say	2SK1066-22	FET	E26
A44	Phi	BAV 74	Diode	E25
A81	Val	BAS 20	Diode	E25
A82	Val	BAS 21	Diode	E25
A91	Val	BAS 17	Diode	E25
AA(p.s)	Sie,Phi,Aeg	BCW 60A	Trans.	E25
AA	Fer			
AA	Tos	2SC4213A	Trans.	E26
AAQ	Rhm	2SD1757K-Q	Trans.	E25
AAQ	Rhm	2SD1757K-R	Trans.	E25
AAS	Rhm	2SD1757K-S	Trans.	E25
AB(p.s)	Sie,Phi,Aeg	BCW 60B	Trans.	E25
AB	Fer,Mot			
AB	Hit	2SD1101-B	Trans.	E25
AB	Tos	2SC4213B	Trans.	E26
ABG	Tos	2SA1312-GR	Trans.	E25
ABL	Tos	2SA1312-BL	Trans.	E25
AC(p.s)	Sie,Phi,Aeg	BCW 60C	Trans.	E25
AC	Mot,Fer			
AC	Hit	2SD1101-C	Trans.	E25
ACL	Rhm	2SC3837K-L	Trans.	E25
ACM	Rhm	2SC3837K-M	Trans.	E25
ACN	Rhm	2SC3837K-N	Trans.	E25
ACO	Tos	2SA1313-D	Trans.	E25
ACP	Rhm	2SC3837K-P	Trans.	E25
ACQ	Rhm	2SC3837K-Q	Trans.	E25
ACY	Tos	2SA1313-Y	Trans.	E25
AD(p.s)	Sie,Phi,Aeg	BCW 60D	Trans.	E25
AD	Fer			
ADL	Rhm	2SC3838K-L	Trans.	E25
ADM	Rhm	2SC3838K-M	Trans.	E25
ADN	Rhm	2SC3838K-N	Trans.	E25
ADP	Rhm	2SC3838K-P	Trans.	E25
ADQ	Rhm	2SC3838K-Q	Trans.	E25
AE	Sie	BCW 60E	Trans.	E25
AE	Mit	2SA1365-E	Trans.	E25
AEG	Tos	2SA1362-GR	Trans.	E25
AEL	Tos	2SA1362-BL	Trans.	E25
AEL	Rhm	2SC3839K-L	Trans.	E25
AEM	Rhm	2SC3839K-M	Trans.	E25
AEN	Rhm	2SC3839K-N	Trans.	E25
AEP	Rhm	2SC3839K-P	Trans.	E25
AEQ	Rhm	2SC3839K-Q	Trans.	E25
AEY	Tos	2SA1362-Y	Trans.	E25
AF(s)	Sie,Val	BCW 60FF	Trans.	E25
AF	Mit	2SA1365-F	Trans.	E25
AFP	Rhm	2SD1781K-F	Trans.	E25
AFQ	Rhm	2SD1781K-Q	Trans.	E25
AFR	Rhm	2SD1781K-R	Trans.	E25
AG(p.s)	Sie,Phi,Mot	BCX 70G	Trans.	E25
AG	Fer			
AG	Mit	2SA1365-G	Trans.	E25
AH(p.s)	Sie,Phi,Mot	BCX 70H	Trans.	E25
AH	Fer			
AH	Say	1SS345	Diode	E25
AIZ	Sam	KSC 3125	Trans.	E25
AJ(p.s)	Sie,Phi,Mot	BCX 70J	Trans.	E25
AJ	Fer			
AJ5	Say	2SK443-AJ5	FET	E25
AJ6	Say	2SK443-AJ6	FET	E25
AJ7	Say	2SK443-AJ7	FET	E25
AK(p.s)	Sie,Phi,Fer	BCX 70K	Trans.	E25
AKQ	Mat	2SA1738-Q	Trans.	E25
AKQ	Mat	2SA1806-Q	Trans.	E40
AKR	Mat	2SA1738-R	Trans.	E25
AKR	Mat	2SA1806-R	Trans.	E40
AL	Sie	BCX 70L	Trans.	E25
AL	Say	2SA1338	Trans.	E25
ALM	Rhm	2SC3802K-M	Trans.	E25
ALN	Rhm	2SC3802K-N	Trans.	E25
ALP	Rhm	2SC3802K-P	Trans.	E25
ALQ	Rhm	2SC3802K-Q	Trans.	E25

Code	Herst.	Typ	Art	Fig.	Code	Herst.	Typ	Art	Fig.	Code	Herst.	Typ	Art	Fig.
ALQ	Mat	2SA1747-Q	Trans.	E25	B26	Phi	BF 570	Trans.	E25	BW4	Nip	2SB736-BW4	Trans.	E25
ALQ	Mat	2SA1748-Q	Trans.	E26	B51	Nip	2SB736A-B51	Trans.	E25	BW5	Nip	2SB736-BW5	Trans.	E25
ALQ	Mat	2SA1791-Q	Trans.	E40	B52	Nip	2SB736A-B52	Trans.	E25	BX	Sie.Val	BCX 71RJ	Trans.	E25
ALR	Mat	2SA1747-R	Trans.	E25	B53	Nip	2SB736A-B53	Trans.	E25	BY	Sie.Val	BCX 71RK	Trans.	E25
ALR	Mat	2SA1748-R	Trans.	E26	B54	Nip	2SB736A-B54	Trans.	E25	BY	Say	2SC4396	Trans.	E26
ALR	Mat	2SA1791-R	Trans.	E40	B55	Nip	2SB736A-B55	Trans.	E25	BY	Say	2SC3395	Trans.	E25
AM(p,s)	Phi,Sie,Mot	BSS 64	Trans.	E25	B81	Val	BSR 12R	Trans.	E25	BZ	Sie	BCX 71RL	Trans.	E25
AMQ	Mat	2SC4561-Q	Trans.	E25	BA(p,s)	Sie,Phi,Aeg	BCW 61A	Trans.	E25	C	Say	2SK1375	FET	E26
AMQ	Mat	2SC4562-Q	Trans.	E26		Fer			E25	C	Say	SB005-09CP	Diode	E25
AMQ	Mat	2SC4656-Q	Trans.	E40	BA	Tos	1SS154	Diode	E25	C1(p)	Phi,Mot,Fer	BCW 29	Trans.	E25
AMR	Mat	2SC4561-R	Trans.	E25	BB(p,s)	Sie,Phi,Aeg	BCW 61B	Trans.	E25	C1	Fer	BFS 38A	Trans.	E26
AMR	Mat	2SC4562-R	Trans.	E26		Fer,Mot			E25	C1	Hit	HSM 88(A)S	Diode	E25
AMR	Mat	2SC4656-R	Trans.	E40	BB	Hit	2SB831-B	Trans.	E25	C1G	Sam	KSC 1632-G	Trans.	E25
AN(s)	Sie	BCW 60FN	Trans.	E25	BB	Tos	1SV128	Diode	E25	C1L	Sam	KSC 1632-L	Trans.	E25
AN	Tos	2SC2532	Trans.	E25	BC	Hit	2SB831-C	Trans.	E25	C1O	Sam	KSC 1632-O	Trans.	E25
AN	Rhm	2SC2413K-N	Trans.	E25	BC(p,s)	Sie,Phi,Aeg	BCW 61C	Trans.	E25	C1Y	Sam	KSC 1632-Y	Trans.	E25
AN	Rhm	2SC4098-N	Trans.	E26		Mot,Fer			E25	C2(p)	Phi,Mot,Fer	BCW 30	Trans.	E25
AO	Sie,Val	BCW 60RA	Trans.	E25	BD(p,s)	Sie,Phi,Aeg	BCW 61D	Trans.	E25	C2	Fer	BFS 38	Trans.	E26
AO	Tos	2SC4210-O	Trans.	E25		Fer			E25	C2	Hit	HSM 276S	Diode	E25
AP	Sie,Val	BCW 60RB	Trans.	E25	BD	Tos	1SS271	Diode	E25	C3	Mot, Sam	MMBT 4126	Trans.	E25
AP	Rhm	2SC2413K-P	Trans.	E25	BE	Sie	BCW 61E	Trans.	E25	C3	Fer	BFS 39	Trans.	E26
AP	Rhm	2SC4098-P	Trans.	E26	BE	Mit	2SC3440-E	Trans.	E25	C3	Tos	1SS226	Diode	E25
AQ	Rhm	2SC2413K-Q	Trans.	E25	BE	Tos	1SV172	Diode	E25	C3	Tos	1SS302	Diode	E26
AQ	Rhm	2SC4098-Q	Trans.	E26	BF(s)	Sie	BCW 61FF	Trans.	E25	C3	Tos	1SS362	Diode	F40
AQ	Mat	2SB709-Q	Trans.	E25	BF	Mit	2SC3440-F	Trans.	E25	C3	Hit	HSM 88(A)SR	Diode	E25
AQ	Mat	2SB1218-Q	Trans.	E40	BF	Tos	1SS268	Diode	E25	C4	Val,Fer	BCW 29R	Trans.	E25
AQ	Mat	2SB1462-Q	Trans.	E40	BF	Tos	1SS312	Diode	E26	C4	Nip	2SA811	Trans.	E25
AR	Sie,Val,Fer	BCW 60RC	Trans.	E25	BG(p,s)	Sie,Phi,Fer	BCX 71G	Trans.	E25	C4	Fer	BFS 40A	Trans.	E26
AR	Mat	2SB709-R	Trans.	E25	BG	Mit	2SC3440-G	Trans.	E25	C4	Mit	MC 804	Diode	E25
AR	Mat	2SB1218-R	Trans.	E26	BG	Tos	1SS269	Diode	E25	C4	Hit	HSM 88WK	Diode	E25
AR	Mat	2SB1462-R	Trans.	E40	BG	Tos	1SS313	Diode	E26	C5	Val,Fer	BCW 30R	Trans.	E25
AS	Sie,Val	BCW 60RD	Trans.	E25	BH(p,s)	Sie,Phi,Fer	BCX 71H	Trans.	E25	C5	Nip	2SA811-C5	Trans.	E25
AS	Say	2SA1655	Trans.	E25		Mot			E25	C5	Sam	MMBA 811C5	Trans.	E25
AS	Mat	2SB709-S	Trans.	E25	BH	Tos	1SS295	Diode	E25	C5	Fer	BFS 40	Trans.	E26
AS	Mat	2SB1218-S	Trans.	E26	BH	Say	1SS350	Diode	E25	C5	Hit	HSM 107S	Diode	E25
AS	Mat	2SB1462-S	Trans.	E40	BIQ	Hit	2SK541-BIQ	FET	E25	C6	Nip	2SA811-C6	Trans.	E25
AS	Sie	BAT 18-05	Diode	E25	BIR	Hit	2SK541-BIR	FET	E25	C6	Sam	MMBA 811C6	Trans.	E25
AT	Sie	BCW 60RE	Trans.	E25	BIS	Hit	2SK541-BIS	FET	E25	C6	Fer	BFS 41	Trans.	E26
AT	Say	2SC4066	Trans.	E25	BJ(p,s)	Sie,Phi,Fer	BCX 71J	Trans.	E25	C6	Hit	HSM 198S	Diode	E25
AT	Sie	BAT 18-06	Diode	E25		Mot			E25	C7(p)	Phi	BCF 29	Trans.	E25
ATQ	Rhm	2SC4326LK-Q	Trans.	E25	BK(p,s)	Sie,Phi,Fer	BCX 71K	Trans.	E25	C7	Nip	2SA811-C7	Trans.	E25
ATR	Rhm	2SC4326LK-R	Trans.	E25	BL	Sie	BCX 71L	Trans.	E25	C7	Sam	MMBA 811C7	Trans.	E25
ATS	Rhm	2SC4326LK-S	Trans.	E25	BL	Say	2SA1676	Trans.	E26	C7	Hit	HSM 88WA	Diode	E25
AU	Sie,Val	BCX 70RG	Trans.	E25	BL	Say	2SA1341	Trans.	E25	C8(p)	Phi	BCF 30	Trans.	E25
AU	Sie	BAT 18-04	Diode	E25	BM(p,s)	Phi,Sie,Mot	BSS 63	Trans.	E25	C8	Nip	2SA811-C8	Trans.	E25
AW	Sie,Val	BCX 70RH	Trans.	E25	BN(s)	Sie	BCW 61FN	Trans.	E25	C8	Sam	MMBA 811C8	Trans.	E25
AX	Sie,Val,Fer	BCX 70RJ	Trans.	E25	BO	Sie,Val	BCW 61RA	Trans.	E25	C9	Val	BCF 30R	Trans.	E25
AX	Mat	2SA1739	Trans.	E26	BP	Sie,Val	BCW 61RB	Trans.	E25	C9	Hit	HSM 276SR	Diode	E25
AY	Sie,Val	BCX 70RK	Trans.	E25	BQ	Rhm	2SC2412K-Q	Trans.	E25	C15	Nip	2SA811A-C15	Trans.	E25
AY	Say	2SC3392	Trans.	E25	BQ	Rhm	2SC4081-Q	Trans.	E26	C16	Nip	2SA811A-C16	Trans.	E25
AY	Tos	2SC4210-Y	Trans.	E25	BQ	Mat	2SB709A-Q	Trans.	E25	C17	Nip	2SA811A-C17	Trans.	E25
AZ	Sie	BCX 70RL	Trans.	E25	BQ	Mat	2SB1218A-Q	Trans.	E26	C18	Nip	2SA811A-C18	Trans.	E25
B	Say	2SK1068	FET	E26	BR	Sie,Val	BCW 61RC	Trans.	E25	C20	Say	2SK595-20	FET	E25
B	Say	SB 05-05CP	Diode	E25	BR	Rhm	2SC2412K-R	Trans.	E25	C21	Say	2SK595-21	FET	E25
B1	Hit	HSM 2692	Diode	E25	BR	Rhm	2SC4081-R	Trans.	E26	C22	Say	2SK595-22	FET	E25
B1O	Sam	KSC 2715-O	Trans.	E25	BR	Mat	2SB709A-R	Trans.	E25	C23	Say	2SK595-23	FET	E25
B1R	Sam	KSC 2715-R	Trans.	E25	BR	Mat	2SB1218A-R	Trans.	E26	C24	Say	2SK595-24	FET	E25
B1Y	Sam	KSC 2715-Y	Trans.	E25	BS	Sie	BCW 61RD	Trans.	E25	C25	Nip	2SA1247-C25	Trans.	E25
B2(p)	Phi,Tho,Mot	BSV 52	Trans.	E25	BS	Say	2SA1669	Trans.	E25	C26	Nip	2SA1247-C26	Trans.	E25
	Fer			E25	BS	Rhm	2SC2412K-S	Trans.	E25	C27	Nip	2SA1247-C27	Trans.	E25
B2	Nip	2SC1621-B2	Trans.	E25	BS	Rhm	2SC4081-S	Trans.	E26	C28	Nip	2SA1247-C28	Trans.	E25
B3	Nip	2SC1621-B3	Trans.	E25	BS	Mat	2SB709A-S	Trans.	E25	C71	Val(+)	BCW 61A	Trans.	E25
B3	Tos	1SS184	Diode	E25	BS	Mat	2SB1218A-S	Trans.	E26	C72	Val(+)	BCW 61B	Trans.	E25
B3	Tos	1SS301	Diode	E26	BT	Sie	BCW 61RE	Trans.	E25	C73	Val(+)	BCW 61C	Trans.	E25
B3	Tos	1SS361	Diode	E40	BT	Say	2SC4069	Trans.	E25	C74	Val(+)	BCW 61D	Trans.	E25
B3	Hit	HSM 2694	Diode	E25	BU	Sie,Val	BCX 71RG	Trans.	E25	C77	Val	BCF 29R	Trans.	E25
B4	Val,Tho,Fer	BSV 52R	Trans.	E25	BV	Say	1SV233	Diode	E25	CA	Fer	BCW 61RA	Trans.	E25
B4	Nip	2SC1621-B4	Trans.	E25	BV	Say	1SV247	Diode	E26	CA	Sie	BFS 18	Trans.	E25
B4	Hit	HSM 2693A	Diode	E25	BV1	Nip	2SB624-BV1	Trans.	E25	CA	Itt	BB 510	Diode	E25
B5(p)	Phi	BSR 12	Trans.	E25	BV2	Nip	2SB624-BV2	Trans.	E25	CB	Fer	BCW 61RB	Trans.	E25
B6	Say	2SB815-6	Trans.	E25	BV3	Nip	2SB624-BV3	Trans.	E25	CB	Sie	BFS 19	Trans.	E25
B7	Say	2SB815-7	Trans.	E25	BV4	Nip	2SB624-BV4	Trans.	E25	CBG	Tos	2SC3324-GR	Trans.	E25
B8	Phi	BSR 12R	Trans.	E25	BV5	Nip	2SB624-BV5	Trans.	E25	CBL	Tos	2SC3324-BL	Trans.	E25
B9	Tos	1SS311	Diode	E25	BW	Sie,Val	BCX 71RH	Trans.	E25	OC	Fer	BCW 61RC	Trans.	E25
B10	Say	2SK545-B10	FET	E25	BW1	Nip	2SB736-BW1	Trans.	E25	OC	Sie	BF 554	Trans.	E25
B11	Say	2SK545-B11	FET	E25	BW2	Nip	2SB736-BW2	Trans.	E25	OC	Hit	2SA1122-C	Trans.	E25
B12	Say	2SK545-B12	FET	E25	BW3	Nip	2SB736-BW3	Trans.	E25	CC A	Tos	2SC3326A	Trans.	E25

Code	Herst.	Typ	Art	Fig.	Code	Herst.	Typ	Art	Fig.	Code	Herst.	Typ	Art	Fig.
CCB	Tos	2SC3326B	Trans.	E25	D4	Say	2SA1252-4	Trans.	E25	DD	Mit	2SC3441-D	Trans.	E25
CD	Fer	BCW61RD	Trans.	E25	D4	Fer	BAW 64	Diode	E26	DE	Hit	2SC2463-E	Trans.	E25
CD(s)	Sie	BSS81B	Trans.	E25	D5	Val,Fer	BCW32R	Trans.	E25	DE	Mit	2SC3441-E	Trans.	E25
CD	Hit	2SA1122-D	Trans.	E25	D5	Say	2SA1252-5	Trans.	E25	DE	Rhm	2SA1037KLN-E	Trans.	E25
CD	Mit	2SA1366-D	Trans.	E25	D5	Fer	BAW65	Diode	E26	DF	Hit	2SC2463-F	Trans.	E25
CE(s)	Sie,Fer,Mot	BSS79B	Trans.	E25	D6	Val,Fer	BCW33R	Trans.	E25	DF(s)	Sie,Fer	BCW68F	Trans.	E25
CE	Hit	2SA1122-E	Trans.	E25	D6	Nip	2SC1622-D6	Trans.	E25	DF	Mit	2SC3441-F	Trans.	E25
CE	Mit	2SA1366-E	Trans.	E25	D6	Say	2SA1252-6	Trans.	E25	DG(s)	Sie,Fer	BCW68G	Trans.	E25
CEO	Tos	2SC3325-O	Trans.	E25	D6	Fer	BAW66	Diode	E26	DG	Tos	2SC2713-GR	Trans.	E25
CEY	Tos	2SC3325-Y	Trans.	E25	D7(p)	Phi	BCF32	Trans.	E25	DG	Tos	2SC4117-GR	Trans.	E26
CF(s)	Sie,Fer,Mot	BSS79C	Trans.	E25	D7	Nip	2SC1622-D7	Trans.	E25	DH(s)	Sie,Fer	BCW68H	Trans.	E25
CF	Mit	2SA1366-F	Trans.	E25	D7	Say	2SA1252-7	Trans.	E25	DK(s)	Sie,Tho	BCX42	Trans.	E25
CG	Fer	BCX71RG	Trans.	E25	D7	Fer	BAW67	Diode	E26	DL	Say	2SA1343	Trans.	E25
CG(s)	Sie	BSS81C	Trans.	E25	D8(p)	Phi	BCF33	Trans.	E25	DL	Tos	2SC2713-BL	Trans.	E25
CG	Tos	2SA1163-GR	Trans.	E25	D8	Nip	2SC1622-D8	Trans.	E25	DL	Tos	2SC4117-BL	Trans.	E26
CG	Tos	2SA1587-GR	Trans.	E25	D8	Fer	BAW68	Diode	E26	DO	Tos	2SA1620-O	Trans.	E25
CGG	Tos	2SC3426-GR	Trans.	E25	D16	Nip	2SC1622A-D16	Trans.	E25	DQ	Mat	2SB710A-Q	Trans.	E25
CGL	Tos	2SC3426-BL	Trans.	E25	D17	Nip	2SC1622A-D17	Trans.	E25	DQ	Mat	2SB1219A-Q	Trans.	E26
CGY	Tos	2SC3426-Y	Trans.	E25	D18	Nip	2SC1622A-D18	Trans.	E25	DR	Rhm	2SA1037KLN-R	Trans.	E25
CH(s)	Sie,Mot	BSS80B	Trans.	E25	D21	Say	2SK931-21	FET	E25	DR	Mat	2SB710A-R	Trans.	E25
CH	Say	1SS351	Diode	E25	D22	Say	2SK931-22	FET	E25	DR	Mat	2SB1219A-R	Trans.	E26
CHO	Tos	2SC3437-O	Trans.	E25	D23	Say	2SK931-23	FET	E25	DS	Sie,Tho	BCX42R	Trans.	E25
CHR	Tos	2SC3437-R	Trans.	E25	D24	Say	2SK931-24	FET	E25	DS	Say	2SA1728	Trans.	E25
CHY	Tos	2SC3437-Y	Trans.	E25	D25	Say	2SK931-25	FET	E25	DS	Rhm	2SA1037KLN-S	Trans.	E25
CHO	Tos	2SC4667-O	Trans.	E26	D25	Nip	2SC5115-D25	Trans.	E25	DS	Mat	2SB710A-S	Trans.	E25
CHR	Tos	2SC4667-R	Trans.	E26	D26	Nip	2SC3115-D26	Trans.	E25	DS	Mat	2SB1219A-S	Trans.	E26
CHY	Tos	2SC4667-Y	Trans.	E26	D27	Nip	2SC3115-D27	Trans.	E25	DT	Sie	BCW67RA	Trans.	E25
CJ(s)	Sie,Mot	BSS80C	Trans.	E25	D28	Nip	2SC3115-D28	Trans.	E25	DT	Say	2SC4112	Trans.	E25
CJ	Say	2SK543	FET	E25	D47	Tho	BZX84/C3V9	Z-Di.	E25	DJ	Sie	BCW67RB	Trans.	E25
CJ	Say	2SK1067	FET	E26	D48	Tho	BZX84/C4V3	Z-Di.	E25	DV1	Nip	2SD596-DV1	Trans.	E25
CK	Fer	BCX71RK	Trans.	E25	D49	Tho	BAY84	Diode	E25	DV2	Nip	2SD596-DV2	Trans.	E25
CL(s)	Sie,Mot,Fer	BSS82B	Trans.	E25	D51	Nip	2SD780A-D51	Trans.	E25	DV3	Nip	2SD596-DV3	Trans.	E25
CL	Say	2SA1677	Trans.	E26	D52	Tho	SoBRY55/3	Thy	E25	DV4	Nip	2SD596-DV4	Trans.	E25
CL	Say	2SA1342	Trans.	E25	D52	Nip	2SD780A-D52	Trans.	E25	DV5	Nip	2SD596-DV5	Trans.	E25
CL	Tos	2SA1163-BL	Trans.	E25	D53	Tho	BAY85	Diode	E25	DVP	Mat	2SC4755-P	Trans.	E26
CL	Tos	2SA1587-BL	Trans.	E26	D53	Nip	2SD780A-D53	Trans.	E25	DVP	Mat	2SC4782-P	Trans.	E25
CM(s)	Sie,Mot,Fer	BSS82C	Trans.	E25	D54	Tho	BZX84/C3V3	Z-Di.	E25	DVQ	Mat	2SC4755-Q	Trans.	E26
CO	Tos	2SC4209-O	Trans.	E25	D54	Nip	2SD780A-D54	Trans.	E25	DVQ	Mat	2SC4782-Q	Trans.	E25
CP	Rhm	2SC2411K-P	Trans.	E25	D55	Nip	2SD780A-D55	Trans.	E25	DVR	Mat	2SC4755-R	Trans.	E26
CP	Rhm	2SC4097-P	Trans.	E26	D62	Tho	BAT53	Diode	E25	DVR	Mat	2SC4782-R	Trans.	E25
OQ	Rhm	2SC2411K-Q	Trans.	E25	D64	Tho	BZX84/C3V6	Z-Di.	E25	DW	Sie	BCW67RC	Trans.	E25
OQ	Rhm	2SC4097-Q	Trans.	E26	D65	Tho	SoBRY55/3	Thy	E25	DW1	Nip	2SD780-DW1	Trans.	E25
OQ	Mat	2SB710-Q	Trans.	E25	D66	Tho	SoBRY55/6	Thy	E25	DW2	Nip	2SD780-DW2	Trans.	E25
OQ	Mat	2SB1219-Q	Trans.	E26	D67	Tho	SoBRY55/6	Thy	E25	DW3	Nip	2SD780-DW3	Trans.	E25
OR	Rhm	2SC2411K-R	Trans.	E25	D71	Val(+)	BCW60A	Trans.	E25	DW4	Nip	2SD780-DW4	Trans.	E25
OR	Rhm	2SC4097-R	Trans.	E26	D72	Val(+)	BCW60B	Trans.	E25	DW5	Nip	2SD780-DW5	Trans.	E25
OR	Mat	2SB710-R	Trans.	E25	D73	Val(+)	BCW60C	Trans.	E25	DX	Sie	BCW68RF	Trans.	E25
OR	Mat	2SB1219-R	Trans.	E26	D73	Tho	BA579A	Diode	E25	DY	Sie	BCW68RG	Trans.	E25
CS	Say	2SA1682	Trans.	E25	D74	Val(+)	BCW60D	Trans.	E25	DY	Say	2SC3397	Trans.	E25
CS	Mat	2SB710-S	Trans.	E25	D74	Tho	BA579C	Diode	E25	DY	Tos	2SA1620-Y	Trans.	E25
CS	Mat	2SB1219-S	Trans.	E26	D75	Tho	BA579S	Diode	E25	DZ	Sie	BCW68RH	Trans.	E25
CT	Say	2SD1935	Trans.	E25	D76	Tho	BAR18	Diode	E25	E	Say	2SA1688	Trans.	E25
CV	Say	1SV234	Diode	E25	D77	Val	BCF32R	Trans.	E25	E	Say	SB002-15CP	Diode	E25
CV	Say	1SV246	Diode	E26	D81	Val	BCF33R	Trans.	E25	E1(p)	Sie,Aeg,Mot	BFS17	Trans.	E25
CY	Sie	BFS18R	Trans.	E25	D81	Tho	BAR43A	Diode	E25		Phi			
CY	Say	2SC4397	Trans.	E26	D82	Tho	BAR43C	Diode	E25	E2	Phi,Aeg	BFS17A	Trans.	E25
CY	Say	2SC3396	Trans.	E25	D83	Sie,Tho	BB503DK	Diode	E25	E2	Nip	2SA1226-E2	Trans.	E25
CY	Tos	2SC4209-Y	Trans.	E25	D84	Tho	BAT18DK	Diode	E25	E2	Fer	BA199	Diode	E25
CYQ	Mat	2SC4661-Q	Trans.	E26	D85	Tho	BAT17DS	Diode	E25	E3	Say	2SA1256-3	Trans.	E25
CYR	CYR	2SC4661-R	Trans.	E26	D94	Tho	BAR42	Diode	E25	E3	Nip	2SA1226-E3	Trans.	E25
CYS	Mat	2SC4661-S	Trans.	E26	D95	Tho	BAR43	Diode	E25	E3	Fer	BAR99	Diode	E25
CZ	Sie	BFS19R	Trans.	E25	D96	Tho	BAS70-04	Diode	E25	E3	Tos	1SS190	Diode	E25
D	Say	2SA1687	Trans.	E26	D97	Tho	BAS70-05	Diode	E25	E4	Val,Aeg	BFS17R	Trans.	E25
D	Say	SB02-09CP	Diode	E25	D98	Tho	BAS70-06	Diode	E25	E4	Say	2SA1256-4	Trans.	E25
D01	Tho	SD914	Diode	E25	DA(s)	Sie,Fer	BCW67A	Trans.	E25	E4	Nip	2SA1226-E4	Trans.	E25
D1(p)	Phi,Fer	BCW31	Trans.	E25	DA2	Tho	SD BAX 12	Diode	E25	E5	Val,Aeg	BFS17AR	Trans.	E25
D1	Fer	BAW63	Diode	E26	DA5	Tho	BAR43S	Diode	E25	E5	Say	2SA1256-5	Trans.	E25
D1G	Sam	KSA812-G	Trans.	E25	DA6	Tho	BZV53A	Z-Di.	E25	E6	Fer	ZC2800E	Diode	E25
D1L	Sam	KSA812-L	Trans.	E25	DA7	Tho	BZV53B	Z-Di.	E25	E7	Fer	ZC2810E	Diode	E25
D1O	Sam	KSA812-O	Trans.	E25	DA8	Tho	BZV54A	Z-Di.	E25	E8	Fer	ZC2811E	Diode	E25
D1Y	Sam	KSA812-Y	Trans.	E25	DA9	Tho	BZV54B	Z-Di.	E25	E9	Fer	ZC5800E	Diode	E25
D2(p)	Phi,Fer,Mot	BCW32	Trans.	E25	DB(s)	Sie,Fer,Mot	BCW67B	Trans.	E25	E15	Phi	BF747	Trans.	E25
D2	Fer	BAW63A	Diode	E26	DB1	Tho	BAR43A	Diode	E25	E16	Phi	BF547	Trans.	E25
D3(p)	Phi,Fer	BCW33	Trans.	E25	DB2	Tho	BAR43C	Diode	E25	E21	Say	2SK932-21	FET	E25
D3	Fer	BAW63B	Diode	E26	DB6	Tho	BAY85S	Diode	E25	E22	Say	2SK932-22	FET	E25
D3	Tos	1SS187	Diode	E25	DC(s)	Sie,Fer	BCW67C	Trans.	E25	E23	Say	2SK932-23	FET	E25
D4	Val,Fer	BCW31R	Trans.	E25	DD	Hit	2SC2463-D	Trans.	E25	E24	Say	2SK932-24	FET	E25

Code	Herst.	Typ	Art	Fig.	Code	Herst.	Typ	Art	Fig.	Code	Herst.	Typ	Art	Fig.
EA(s)	Sie,Fer	BCW65A	Trans.	E25	F15	Tho	SO5432	FET	E25	G4	Nip	2SC2107-G4	Trans.	E25
EA	Mat	2SA1022-A	Trans.	E25	F16	Tho	SO5432R	FET	E25	G4	Say	2SA1257-4	Trans.	E25
EA	Mat	2SA1532-A	Trans.	E26	F17	Tho	SO5433	FET	E25	G5	Val,Aeg	BF550R	Trans.	E25
EA	Mat	2SA1790-A	Trans.	E40	F18	Tho	SO5433R	FET	E25	G5	Nip	2SC2107-G5	Trans.	E25
EB(s)	Sie,Fer,Mot	BCW65B	Trans.	E25	F19	Tho	SO5434	FET	E25	G5	Say	2SA1257-5	Trans.	E25
EB	Mat	2SA1022-B	Trans.	E25	F20	Tho	SO245BR	FET	E25	G6	Val	BF569	Trans.	E25
EB	Mat	2SA1532-B	Trans.	E26	F21	Tho	SO245A	FET	E25	G6	Nip	2SC2107-G6	Trans.	E25
EB	Mat	2SA1790-B	Trans.	E40	F22	Tho	SO4091R	FET	E25	G7	Val,Aeg	BF579	Trans.	E25
EC(s)	Sie,Fer,Mot	BCW65C	Trans.	E25	F23	Tho	SO4391R	FET	E25	G8	Val	BF660	Trans.	E25
EC	Hit	2SC2732	Trans.	E25	F24	Tho	SO245AR	FET	E25	G9	Val	BF767	Trans.	E25
EC	Hit	2SC4462	Trans.	E26	F25	Tho	SO245C	FET	E25	G61	Fer	BF569R	Trans.	E25
EC	Mat	2SA1022-C	Trans.	E25	F26	Tho	SO245CR	FET	E25	G81	Val	BF660R	Trans.	E25
EC	Mat	2SA1532-C	Trans.	E26	F27	Tho	SO4392R	FET	E25	GA	Sie	BFR35	Trans.	E25
EC	Mat	2SA1790-C	Trans.	E40	F28	Tho	SO4393R	FET	E25	GA	Aeg	S416T	Trans.	E25
EF(s)	Sie,Fer	BCW66F	Trans.	E25	F29	Tho	SO3966R	FET	E25	GB	Sie	BFR35A	Trans.	E25
EG(s)	Sie,Fer	BCW66G	Trans.	E25	F30	Tho	SO4092R	FET	E25	GC	Hit	2SC2734	Trans.	E25
EH(s)	Sie,Fer	BCW66H	Trans.	E25	F31	Val	BF841	Trans.	E25	GC	Hit	2SC4264	Trans.	E26
EK(s)	Sie,Tho	BCX41	Trans.	E25	F31	Tho	SO4093R	FET	E25	GE	Sie	BFR35AP	Trans.	E25
EL	Say	2SA1678	Trans.	E26	F32	Tho	SO5434R	FET	E25	GE	Rhm	2SA1455K-E	Trans.	E25
EL	Say	2SA1344	Trans.	E25	FA	Sie	BSV65A	Trans.	E25	GF	Sie	BFR92P	Trans.	E25
EO	Tos	2SC3265-O	Trans.	E25	FA	Hit	2SC2619-A	Trans.	E25	GF	Sie	BFN22	Trans.	E25
ES	Sie,Tho	BCX41R	Trans.	E25	FB	Sie	BSV65B	Trans.	E25	GG	Sie	BFR93P	Trans.	E25
ES	Say	2SA1745	Trans.	E26	FB	Hit	2SC2619-B	Trans.	E25	GG	Aeg	BF579R	Trans.	E25
ES	Say	2SA1753	Trans.	E25	FB	Mit	2SC3053-B	Trans.	E25	GJ2	Say	2SK968-2	FET	E25
ET	Sie	BCW65RA	Trans.	E25	FB	Mit	2SC4258-B	Trans.	E26	GJ3	Say	2SK968-3	FET	E25
ET	Say	2SC4120	Trans.	E25	FC	Hit	2SC2619-C	Trans.	E25	GJ4	Say	2SK968-4	FET	E25
EJ	Sie	BCW65RB	Trans.	E25	FC	Mit	2SC3053-C	Trans.	E25	GJ5	Say	2SK968-5	FET	E25
EW	Sie	BCW65RC	Trans.	E25	FC	Mit	2SC4258-C	Trans.	E26	GL	Say	2SA1496	Trans.	E25
EX	Sie	BCW66RF	Trans.	E25	FD(p,s)	Phi,Sie,Tho	BCV26	Trans.	E25	GO	Tos	2SC2996-O	Trans.	E25
EY	Sie	BCW66RG	Trans.	E25	FD	Mit	2SC3053-D	Trans.	E25	GR	Tos	2SC2996-R	Trans.	E25
EY	Say	2SC4398	Trans.	E26	FD	Mit	2SC4258-D	Trans.	E26	GR	Rhm	2SA1455K-R	Trans.	E25
EY	Tos	2SC3265-Y	Trans.	E25	FE(p,s)	Phi,Sie,Tho	BCV46	Trans.	E25	GS	Rhm	2SA1455K-S	Trans.	E25
EY	Say	2SC3398	Trans.	E25	FF(p,s)	Phi,Sie,Tho	BCV27	Trans.	E25	GT	Say	2SC4443	Trans.	E26
EZ	Sie	BCW66RH	Trans.	E25	FG(p,s)	Phi,Sie	BCV47	Trans.	E25	GT	Say	2SC4168	Trans.	E25
F	Say	2SC4399	Trans.	E26	FH(s)	Sie	BFN24	Trans.	E25	GY	Say	2SC4413	Trans.	E26
F	Say	SB01-15CP	Diode	E25	FJ(s)	Sie	BFN26	Trans.	E25	GY	Say	2SC3689	Trans.	E25
F1(p)	Phi,Tho,Mul	BFS18	Trans.	E25	FJ	Say	2SK1069	FET	E26	GY	Tos	2SC2996-Y	Trans.	E25
F1	Mot,Nip	2SC1009-F1	Trans.	E25	FJ3	Say	2SK771-3	FET	E26	GZ	Sie	BFR35AR	Trans.	E25
		=MMBC1009F1		E25	FJ4	Say	2SK771-4	FET	E25	H	Say	2SC4446	Trans.	E26
F10	Sam	KSA1182-O	Trans.	E25	FJ5	Say	2SK771-5	FET	E25	H0	Tos	2SC4252	Trans.	E26
F1Y	Sam	KSA1182-Y	Trans.	E25	FK(s)	Sie	BFN25	Trans.	E25	H0	Tos	2SC4255	Trans.	E25
F2(p)	Phi,Tho,Mul	BFS19	Trans.	E25	FL(s)	Sie	BFN27	Trans.	E25	H	Say	SB02-03C	Diode	E25
F2	Mot,Nip	2SC1009-F2	Trans.	E25	FL	Say	2SA1434	Trans.	E25	H	Say	SB02-03Q	Diode	E26
		=MMBC1009F2		E25	FM	Aeg,Sie	BB804	Diode	E25	H1(p)	Phi,Fer	BCW69	Trans.	E25
F2	Say	2SC2814-F2	Trans.	E25	FO	Tos	2SC2716-O	Trans.	E25	H1	Fer	BFS46	Trans.	E26
F02	Tho	SO4091	FET	E25	FOI	Tho	SO4416	FET	E25	H1	Hit	HVM187WK	Diode	E25
F3	Val	BF840	Trans.	E25	FQ	Rhm	2SA1037K-Q	Trans.	E25	H10	Sam	KSC2755-O	Trans.	E25
F3	Mot,Nip	2SC1009-F3	Trans.	E25	FQ	Rhm	2SA1576-Q	Trans.	E26	H10	Sam	KSC2859-O	Trans.	E25
		=MMBC1009F3		E25	FR	Tos	2SC2716-R	Trans.	E25	H1R	Sam	KSC2755-R	Trans.	E25
F3	Say	2SC2814-F3	Trans.	E25	FR	Rhm	2SA1037K-R	Trans.	E25	H1Y	Sam	KSC2755-Y	Trans.	E25
F03	Tho	SO4391	FET	E25	FR	Rhm	2SA1576-R	Trans.	E26	H1Y	Sam	KSC2859-Y	Trans.	E25
F3	Tos	1SS193	Diode	E25	FR	Mat	2SA1034-R	Trans.	E25	H2(p)	Phi,Fer,Mot	BCW70	Trans.	E25
F4	Mot,Nip	2SC1009-F4	Trans.	E25	FR	Mat	2SA1531-R	Trans.	E26	H2	Fer	BFS46A	Trans.	E26
		=MMBC1009F4		E25	FS	Say	2SA1763	Trans.	E26	H2	Hit	HVM13	Diode	E25
F4	Val,Tho,Mul	BFS18R	Trans.	E25	FS	Say	2SA1764	Trans.	E25	H20	Sam	KSC2756-O	Trans.	E25
F4	Say	2SC2814-F4	Trans.	E25	FS	Rhm	2SA1037K-S	Trans.	E25	H2R	Sam	KSC2756-R	Trans.	E25
F5	Val,Tho,Mul	BFS19R	Trans.	E25	FS	Rhm	2SA1576-S	Trans.	E26	H2Y	Sam	KSC2756-Y	Trans.	E25
	Aeg		E25	FS	Mat	2SA1034-S	Trans.	E25	H3(p)	Phi,Fer,Tho	BCW89	Trans.	E25	
F5	Mot,Nip	2SC1009-F5	Trans.	E25	FS	Mat	2SA1531-S	Trans.	E26	H3	Nip	2SA956-H3	Trans.	E25
		=MMBC1009F5		E25	FT	Say	2SC4146	Trans.	E25	H3	Hit	HVM187S	Diode	E25
F5	Say	2SC2814-F5	Trans.	E25	FT	Mat	2SA1034-T	Trans.	E25	H30	Sam	KSC2757-O	Trans.	E25
F5	Tos	1SS250	Diode	E25	FT	Mat	2SA1531-T	Trans.	E26	H3R	Sam	KSC2757-R	Trans.	E25
F6	Nip	2SC2223-F6	Trans.	E25	FY	Sie	BSV65RA	Trans.	E25	H3Y	Sam	KSC2757-Y	Trans.	E25
F07	Tho	SO4392	FET	E25	FY	Say	2SC3661	Trans.	E25	H4	Val,Fer	BCW69R	Trans.	E25
F7	Hit	HSM83	Diode	E25	FY	Tos	2SC2716-Y	Trans.	E25	H4	Nip	2SA956-H4	Trans.	E25
F8(p)	Phi	BF824	Trans.	E25	FZ	Sie	BSV65RB	Trans.	E25	H4	Say	2SC3134-4	Trans.	E25
F08	Tho	SO4393	FET	E25	G	Say	SB007-03CP	Diode	E25	H4	Hit	HVM121WK	Diode	E25
F09	Tho	SO3966	FET	E25	G	Say	SB007W03Q	Diode	E26	H4Z	Sam	KSC2758	Trans.	E25
F9	Tos	1SS321	Diode	E25	G1(p)	Phi,Tho,Mul	BFS20	Trans.	E25	H5	Val,Fer	BCW70R	Trans.	E25
F10	Tho	SO4092	FET	E25		Fer		E25	H5	Nip	2SA956-H5	Trans.	E25	
F11	Tho	SO4093	FET	E25	G2	Val,Aeg	BF550	Trans.	E25	H5	Say	2SC3134-5	Trans.	E25
F12	Nip	2SC2223-F12	Trans.	E25	G3	Val	BF536	Trans.	E25	H5	Hit	HVM14	Diode	E25
F12	Tho	SO245B	FET	E25	G3	Nip	2SC2107-G3	Trans.	E25	H50	Sam	KSC2223-O	Trans.	E25
F13	Nip	2SC2223-F13	Trans.	E25	G3	Say	2SA1257-3	Trans.	E25	H5R	Sam	KSC2223-R	Trans.	E25
F13	Tho	BFR30R	FET	E25	G3	Tos	1SS196	Diode	E25	H5Y	Sam	KSC2223-Y	Trans.	E25
F14	Nip	2SC2223-F14	Trans.	E25	G4	Val,Tho,Mul	BFS20R	Trans.	E25	H6	Fer	BCW89R	Trans.	E25
F14	Tho	BFR31R	FET	E25		Fer,Aeg		E25	H6	Nip	2SA956-H6	Trans.	E25	

Code	Herst.	Typ	Art	Fig.	Code	Herst.	Typ	Art	Fig.	Code	Herst.	Typ	Art	Fig.
H6	Say	2SC3134-6	Trans.	E25	IHF	Hit	2SK431-F	FET	E25	JG(s)	Sie,Tho	BAR 99	Diode	E25
H6	Hit	HVM 14S	Diode	E25	IJ	Hit	2SC3374	Trans.	E25	JG	Tos	2SK208-G	FET	E25
H6O	Sam	KSC 2759-O	Trans.	E25	IL	Hit	2SC3493	Trans.	E25	JG	Tos	2SK879-GR	FET	E26
H6R	Sam	KSC 2759-R	Trans.	E25	IL	Hit	2SC4263	Trans.	E26	JH	Aeg,Sie	BAV 70	Diode	E25
H6Y	Sam	KSC 2759-Y	Trans.	E25	INB	Hit	2SA1468-B	Trans.	E25	JID	Hit	2SA1566-D	Trans.	E25
H7(p)	Phi	BCF 70	Trans.	E25	INC	Hit	2SA1466-C	Trans.	E25	JIE	Hit	2SA1566-E	Trans.	E25
H7	Say	2SC3134-7	Trans.	E25	IO	Tos	2SA1298-O	Trans.	E25	JJ	Sie(+)	BAV 70	Diode	E25
H7	Hit	HVM 14SR	Diode	E25	IP	Hit	2SC3793	Trans.	E25	JJ	Aeg	BAW 56	Diode	E25
H9	Tos	1SS344	Diode	E25	IP	Hit	2SC4262	Trans.	E26	JL	Say	2SA1508	Trans.	E25
H11	Val(+)	BCX 71G	Trans.	E25	IQ	Mat	2SB792-Q	Trans.	E25	JM	Rhm	2SC2059K-M	Trans.	E25
H12	Val(+)	BCX 71H	Trans.	E25	IQ	Mat	2SB1220-Q	Trans.	E26	JM	Rhm	2SC4099-M	Trans.	E26
H13	Val(+)	BCX 71J	Trans.	E25	IR	Rhm	2SC3722K-R	Trans.	E25	JN	Rhm	2SC2059K-N	Trans.	E25
H14	Val(+)	BCX 71K	Trans.	E25	IR	Mat	2SB792-R	Trans.	E25	JN	Rhm	2SC4099-N	Trans.	E26
H31	Val	BCW 89R	Trans.	E25	IR	Mat	2SB1220-R	Trans.	E26	JO	Tos	2SK208-O	FET	E25
H71	Val	BCF 70R	Trans.	E25	IR	Mat	2SB1463-R	Trans.	E40	JO	Tos	2SK879-O	FET	E26
HA	Sie	BSS 25	Trans.	E25	IRD	Hit	2SA1484-D	Trans.	E25	JP(s,p)	Sie,Phi	BAS 19	Diode	E25
HA	Tos	2SC3119	Trans.	E25	IRE	Hit	2SA1484-E	Trans.	E25	JP	Rhm	2SC2059K-P	Trans.	E25
HB(s)	Sie	BFN 22	Trans.	E25	IS	Hit	2SC3513	Trans.	E25	JP	Rhm	2SC4099-P	Trans.	E26
HB	Tos	2SC4245	Trans.	E26	IS	Hit	2SC4537	Trans.	E26	JR	Tos	2SK208-R	FET	E25
HB	Tos	2SC3120	Trans.	E25	IS	Rhm	2SC3722K-S	Trans.	E25	JR(s,p)	Sie,Phi	BAS 20	Diode	E25
HC(s)	Sie	BFN 23	Trans.	E25	IS	Mat	2SB792-S	Trans.	E25	JR	Tos	2SK879-R	FET	E26
HC	Hit	2SC2733	Trans.	E25	IS	Mat	2SB1220-S	Trans.	E26	JS(s,p)	Sie,Phi	BAS 21	Diode	E25
HC	Tos	2SC4246	Trans.	E26	IS	Mat	2SB1463-S	Trans.	E40	JT	Say	2SC4269	Trans.	E25
HC	Tos	2SC3121	Trans.	E25	IT	Mat	2SB792-T	Trans.	E25	JT	Say	2SC4006	Trans.	E25
HC	Hit	2SC4463	Trans.	E26	IT	Mat	2SB1220-T	Trans.	E26	JU	Sie,Tho,Mot	BAS 16	Diode	E25
HD	Tos	2SC4249	Trans.	E26	IT	Mat	2SB1463-T	Trans.	E40					E25
HD	Tos	2SC3122	Trans.	E25	IY	Tos	2SA1298-Y	Trans.	E25	JV(s)	Sie	BAS 116	Diode	E25
HE	Tos	2SC4250	Trans.	E26	J	Say	SB 07-03C	Diode	E25	JXs	Sie	BAV 170	Diode	E25
HE	Tos	2SC3123	Trans.	E25	J01	Tho	SO 2906R	Trans.	E25	JY	Say	2SC3770	Trans.	E25
HF	Sie	BFN 23	Trans.	E25	J1	Fer	ZC 830A	Diode	E25	JY	Tos	2SK208-Y	FET	E25
HF	Tos	2SC4251	Trans.	E26	J1	Hit	HSM 402WK	Diode	E25	JY	Tos	2SK879-Y	FET	E26
HF	Tos	2SC3124	Trans.	E25	J1O	Sam	KSA 1298-O	Trans.	E25	JYs	Sie	BAV 199	Diode	E25
HH	Tos	2SC4253	Trans.	E26	J1Y	Sam	KSA 1298-Y	Trans.	E25	JZ(s)	Sie	BAW 156	Diode	E25
HH	Tos	2SC3125	Trans.	E25	J2	Nip	2SK67-J2	FET	E25	K	Say	SB 007W03C	Diode	E25
HI	Tos	2SC4247	Trans.	E26	J2	Say	2SC3142-2	Trans.	E25	K	Say	SB 007W03Q	Diode	E26
HL	Say	2SA1722	Trans.	E26	J3	Nip	2SK67-J3	FET	E25	K1(p)	Phi,Fer	BCW 71	Trans.	E25
HL	Tos	2SC3862	Trans.	E25	J3	Say	2SC3142-3	Trans.	E25	K1	Nip	2SK57-K1	FET	E25
HL	Say	2SA1502	Trans.	E25	J03	Tho	SO 2907AR	Trans.	E25	K1O	Sam	KSC 3265-O	Trans.	E25
HM	Tos	2SC4248	Trans.	E26	J3	Fer	ZC 831A	Diode	E25	K1Y	Sam	KSC 3265-Y	Trans.	E25
HM	Tos	2SC3547B	Trans.	E25	J3	Hit	HSM 402S	Diode	E25	K2(p)	Phi,Fer,Mot	BCW 72	Trans.	E25
HN	Tos	2SC4244	Trans.	E26	J4	Nip	2SK67-J4	FET	E25	K2	Nip	2SK57-K2	FET	E25
HP	Tos	2SC4527	Trans.	E25	J4	Say	2SC3142-4	Trans.	E25	K3(p)	Phi	BCW 81	Trans.	E25
HP	Rhm	2SA1036K-P	Trans.	E25	J4	Fer	ZC 832A	Diode	E25	K3	Nip	2SK57-K3	FET	E25
HP	Rhm	2SA1577-P	Trans.	E26	J5	Nip	2SK67-J5	FET	E25	K3	Say	2SC3143-3	Trans.	E25
HQ	Mit	2SC3928-Q	Trans.	E25	J05	Tho	SO 2907R	Trans.	E25	K4	Val,Fer	BCW 71R	Trans.	E25
HQ	Mit	2SC4155-Q	Trans.	E26	J5	Fer	ZC 834A	Diode	E25	K4	Nip	2SK160-K4	FET	E25
HQ	Rhm	2SA1036K-Q	Trans.	E25	J6	Nip	2SK67-J6	FET	E25	K4	Say	2SC3143-4	Trans.	E25
HQ	Rhm	2SA1577-Q	Trans.	E26	J06	Tho	SO 2894R	Trans.	E25	K5	Val	BCW 72R	Trans.	E25
HR	Mit	2SC3928-R	Trans.	E25	J6	Fer	ZC 835A	Diode	E25	K5	Nip	2SK160-K5	FET	E25
HR	Mit	2SC4155-R	Trans.	E26	J7	Nip	2SK67-J7	FET	E25	K5	Say	2SC3143-5	Trans.	E25
HR	Rhm	2SA1036K-R	Trans.	E25	J7	Fer	ZC 836A	Diode	E25	K6	Fer	BCV 71R	Trans.	E25
HR	Rhm	2SA1577-R	Trans.	E26	J8	Fer	BCX 71RJ	Trans.	E25	K6	Nip	2SK160-K6	FET	E25
HR	Mat	2SA1035-R	Trans.	E25	J8	Nip	2SK67-J8	FET	E25	K7(p)	Phi,Fer	BCV 71	Trans.	E25
HR	Mat	2SA1531A-R	Trans.	E26	J12	Tho	SO 2906AR	Trans.	E25	K7	Nip	2SK160-K7	FET	E25
HS	Mit	2SC3928-S	Trans.	E25	J18	Tho	SO 679R	Trans.	E25	K8(p)	Phi,Fer	BCV 72	Trans.	E25
HS	Mit	2SC4155-S	Trans.	E26	J25	Tho	SO 3906R	Trans.	E25	K9	Fer	BCV 72R	Trans.	E25
HS	Mat	2SA1035-S	Trans.	E25	J26	Tho	SO 3905R	Trans.	E25	K9(p)	Phi	BCF 81	Trans.	E25
HS	Mat	2SA1531A-S	Trans.	E26	J32	Tho	SO 5400R	Trans.	E25	K9	Tos	1SS348	Diode	E25
HT	Mit	2SC3928-T	Trans.	E25	J33	Tho	SO 5401R	Trans.	E25	K11	Val(+)	BCX 70G	Trans.	E25
HT	Mit	2SC4155-T	Trans.	E26	J39	Tho	SO 692R	Trans.	E25	K12	Val(-)	BCX 70H	Trans.	E25
HT	Mat	2SA1035-T	Trans.	E25	J40	Tho	SO 506R	Trans.	E25	K13	Val(-)	BCX 70J	Trans.	E25
HT	Mat	2SA1531A-T	Trans.	E26	J88	Tho	SO 970R	Trans.	E25	K14	Val(-)	BCX 70K	Trans.	E25
I9	Tos	1SS336	Diode	E25	JA(p,s)	Sie,Tho,Mot	BAV 74	Diode	E25	K14	Nip	2SK238-K14	FET	E25
IC	Hit	2SC3016	Trans.	E25		Fer			E25	K15	Nip	2SK238-K15	FET	E25
ID	Hit	2SC3127	Trans.	E25	JB(s)	Sie,Tho	BAR 74	Diode	E25	K16	Nip	2SK238-K16	FET	E25
IE	Rhm	2SC3722K-E	Trans.	E25	JC(s,p)	Sie,Tho,Phi	BAL 74	Diode	E25	K17	Nip	2SK238-K17	FET	E25
IFB	Hit	2SB973-B	Trans.	E25	JC	Hit	2SC2735	Trans.	E25	K24	Nip	2SK160A-K24	FET	E25
IFC	Hit	2SB973-C	Trans.	E25	JC	Mit	2SJ125-C	FET	E25	K25	Nip	2SK160A-K25	FET	E25
IGD	Hit	2SK360-D	FET	E25	JC	Mit	2SJ145-C	FET	E26	K26	Nip	2SK160A-K26	FET	E25
IGD	Hit	2SK1215-D	FET	E26	JC	Hit	2SC4265	Trans.	E26	K27	Nip	2SK160A-K27	FET	E25
IGE	Hit	2SK360-E	FET	E25	JD	Sie,Tho(+)	BAW 56	Diode	E25	K31	Val	BCW 81R	Trans.	E25
IGE	Hit	2SK1215-E	FET	E26	JD	Mit	2SJ125-D	FET	E25	K41	Nip	2SK520-K41	FET	E25
IGF	Hit	2SK360-F	FET	E25	JD	Mit	2SJ145-D	FET	E26	K42	Nip	2SK520-K42	FET	E25
IGF	Hit	2SK1215-F	FET	E26	JE	Aeg,Sie(+)	BAV 99	Diode	E25	K43	Nip	2SK520-K43	FET	E25
IHC	Hit	2SK431-C	FET	E25	JE	Mit	2SJ125-E	FET	E25	K44	Nip	2SK520-K44	FET	E25
IHD	Hit	2SK431-D	FET	E25	JE	Mit	2SJ145-E	FET	E26	K45	Nip	2SK520-K45	FET	E25
IHE	Hit	2SK431-E	FET	E25	JF(s,p)	Sie,Tho	BAL 99	Diode	E25	K51	Nip	2SK508-K51	FET	E25

Code	Herst.	Typ	Art	Fig.	Code	Herst.	Typ	Art	Fig.	Code	Herst.	Typ	Art	Fig.
K52	Nip	2SK508-K52	FET	E25	L9	Sie	BAR 16-1	Diode	E25	M1U	Mat	MA 716	Diode	E25
K53	Nip	2SK508-K53	FET	E25	L9	Tos	1SS349	Diode	E25	M1U	Mat	MA 742	Diode	E26
K71	Val	BCV 71R	Trans.	E25	L20	Val	BAS 29	Diode	E25	M1X	Mat	MA 75WA	Diode	E25
K81	Val	BCV 72R	Trans.	E25	L21	Val	BAS 31	Diode	E25	M1X	Mat	MA 80WA	Diode	E26
K91	Val	BCF 81R	Trans.	E25	L22	Val	BAS 35	Diode	E25	M1Y	Mat	MA 75WK	Diode	E25
KA	Sie	BFT 75	Trans.	E25	L31	Phi	BAV 23S	Diode	E25	M1Y	Mat	MA 80WK	Diode	E26
KAG	Tos	2SK368-GR	FET	E25	L42	Phi	BAT 54A	Diode	E25	M1Z	Mat	MA 727	Diode	E25
KAO	Tos	2SK368-O	FET	E25	L43	Phi	BAT 54C	Diode	E25	M2(p)	Phi, Mot, Tho	BFR 31	FET	E25
KAY	Tos	2SK368-Y	FET	E25	L44	Phi	BAT 54S	Diode	E25	M2E	Mat	MA 164	Diode	E25
KB	Sie	BFQ 29	Trans.	E25	L52	Phi	BAS 678	Diode	E25	M2F	Mat	BA 198	Diode	E25
KB	Hit	2SK323-B	FET	E25	LA(p)	Phi, Sie	BF 550	Trans.	E25	M2H	Mat	MA 555	Diode	E25
KB	Mit	2SK433-B	FET	E25	LB	Hit	2SC2462-B	Trans.	E25	M2M	Mat	MA 717	Diode	E25
KB	Mat	2SC2778-B	Trans.	E25	LC	Hit	2SC2462-C	Trans.	E25	M2M	Mat	MA 745	Diode	E26
KB	Mat	2SC3936-B	Trans.	E26	LD	Hit	2SC2462-D	Trans.	E25	M2P	Mat	MA 704WA	Diode	E25
KB	Mat	2SC4655-B	Trans.	E40	LD	Sie	BF 543	FET	E25	M2P	Mat	MA 741WA	Diode	E26
KC	Sie	BFQ 29P	Trans.	E25	LE(p)	Phi, Sie	BF 660	Trans.	E25	M2R	Mat	MA 704WK	Diode	E25
KC	Hit	2SK323-C	FET	E25	LE	Mit	2SC3052-E	Trans.	E25	M2R	Mat	MA 741WK	Diode	E26
KC	Mit	2SK433-C	FET	E25	LE	Mit	2SC4154-E	Trans.	E26	M2W	Mat	MA 720	Diode	E25
KC	Mit	2SK930-C	FET	E26	LE	Rhm	2SC2412KLN-E	Trans.	E25	M2W	Mat	MA 744	Diode	E26
KC	Mat	2SC2778-C	Trans.	E25	LF	Mit	2SC3052-F	Trans.	E25	M2X	Mat	MA 730	Diode	E25
KC	Mat	2SC3936-C	Trans.	E26	LF	Mit	2SC4154-F	Trans.	E26	M2Y	Mat	MA 715	Diode	E25
KC	Mat	2SC4655-C	Trans.	E40	LFs	Sie	BF 777	Trans.	E25	M3	Val, Mot, Tho	BFT 46	FET	E25
KCG	Tos	2SK625-G	FET	E25	LG	Sie	BF 767	Trans.	E25	M3	Nip	2SA812-M3	Trans.	E25
KCO	Tos	2SK625-O	FET	E25	LG	Tos	2SC2712-GR	Trans.	E25	M3	Sam	MMBA812M3	Trans.	E25
KCR	Tos	2SK625-R	FET	E25	LG	Tos	2SC4116-GR	Trans.	E26	M3A	Mat	MA 199	Diode	E25
KCY	Tos	2SK625-Y	FET	E25	LG	Tos	2SC4738-GR	Trans.	E40	M3C	Mat	MA 740	Diode	E25
KD	Hit	2SK323-D	FET	E25	LG	Mit	2SC3052-G	Trans.	E25	M3D	Mat	MA 717WK	Diode	E25
KD	Mit	2SK433-D	FET	E25	LG	Mit	2SC4154-G	Trans.	E26	M3D	Mat	MA 745WK	Diode	E26
KD	Mit	2SK930-D	FET	E26	LG	Sie	BF 775A	Trans.	E25	M3E	Mat	MA 717WA	Diode	E25
KE	Hit	2SK323-E	FET	E25	LH(p)	Aeg, Phi, Sie, Tho	BF 569	Trans.	E25	M3E	Mat	MA 745WA	Diode	E26
KE	Tos	2SK1062	FET	E25	LJ(p)	Phi, Sie	BF 579	Trans.	E25	M3F	Mat	MA 721WK	Diode	E25
KE	Mit	2SK433-E	FET	E25	LK	Sie	BF 799	Trans.	E25	M3H	Mat	MA 721WA	Diode	E25
KE	Mit	2SK930-E	FET	E26	LK	Sie	BF 568	Trans.	E25	M3O	Mat	MA 557	Diode	E25
KF	Tos	2SJ168	FET	E25	LL	Say	2SA1518	Trans.	E25	M4(p)	Phi, Tho	BSR 56	FET	E25
KG	Tos	2SK211-GR	FET	E25	LL	Tos	2SC2712-BL	Trans.	E25	M4	Nip	2SA812-M4	Trans.	E25
KG	Tos	2SK881-GR	FET	E26	LL	Tos	2SC4116-BL	Trans.	E26	M4	Say	2SA1179-M4	Trans.	E25
KID	Hit	2SC4050-D	Trans.	E25	LL	Tos	2SC4738-BL	Trans.	E40	M4	Sam	MMBA812M4	Trans.	E25
KIE	Hit	2SC4050-E	Trans.	E25	LM	Aeg	BF 569R	Trans.	E25	M5(p)	Phi, Tho	BSR 57	FET	E25
KL	Say	2SA1510	Trans.	E25	LO	Tos	2SC2712-O	Trans.	E25	M5	Nip	2SA812-M5	Trans.	E25
KO	Tos	2SK211-O	FET	E25	LO	Tos	2SC4116-O	Trans.	E26	M5	Say	2SA1179-M5	Trans.	E25
KO	Tos	2SK881-O	FET	E26	LO	Sie	BF 775	Trans.	E25	M5	Sam	MMBA812M5	Trans.	E25
KT	Say	2SC4270	Trans.	E25	LO	Phi, Val	BSR 174	FET	E25	M6(p)	Phi, Tho	BSR 58	FET	E25
KT	Say	2SC4007	Trans.	E25	LO	Tos	2SC4116-O	Trans.	E26	M6	Fer	BSS 66	Trans.	E25
KX	Phi	PMBF 170	FET	E25	LP	Phi	BSR 175	FET	E25	M6	Nip	2SA812-M6	Trans.	E25
KY	Say	2SC3771	Trans.	E25	LQ	Mat	2SD814A-Q	Trans.	E25	M6	Say	2SA1179-M6	Trans.	E25
KY	Tos	2SK881	FET	E26	LQ	Mat	2SD1821A-Q	Trans.	E26	M6	Sam	MMBA812M6	Trans.	E25
KY	Tos	2SK211-Y	FET	E25	LQ	Mat	2SD2240A-Q	Trans.	E40	M7	Fer	BSS 67	Trans.	E25
KY	Tos	2SK881-Y	FET	E26	LQ	Phi	BSR 176	FET	E25	M7	Nip	2SA812-M7	Trans.	E25
L	Say	2SC4211	Trans.	E26	LR	Sie	BF 517	Trans.	E25	M7	Say	2SA1179-M7	Trans.	E25
L	Say	SB 02W03C	Diode	E25	LR	Phi, Val	BSR 177	FET	E25	M7	Sam	MMBA812M7	Trans.	E25
L1	Fer	BSS 65	Trans.	E25	LR	Rhm	2SC2412KLN-R	Trans.	E25	M8	Fer	BSS 66R	Trans.	E25
L1	Fer	BFS 36	Trans.	E26	LR	Mat	2SD814A-R	Trans.	E25	M08	Phi	PMBFJ308	FET	E25
L2	Fer	BSS 69	Trans.	E25	LR	Mat	2SD1821A-R	Trans.	E26	M9	Fer	BSS 67R	Trans.	E25
L2	Fer	BFS 36A	Trans.	E26	LR	Mat	2SD2240A-R	Trans.	E40	M09	Phi	PMBFJ309	FET	E25
L3	Fer	BSS 70	Trans.	E25	LS	Sie	BF 770A	Trans.	E25	M10	Phi	PMBFJ310	FET	E25
L3	Nip	2SC1623-L3	Trans.	E25	LS	Rhm	2SC2412KLN-S	Trans.	E25	M41	Phi	BSR 111	FET	E25
L3	Fer	BFS 37	Trans.	E26	LS	Mat	2SD814A-S	Trans.	E25	M42	Phi	BSR 112	FET	E25
L4	Fer	BSS 65R	Trans.	E25	LS	Mat	2SD1821A-S	Trans.	E26	M43	Phi	BSR 113	FET	E25
L4	Nip	2SC1623-L4	Trans.	E25	LS	Mat	2SD2240A-S	Trans.	E40	M62	Phi, Val(+)	PMBF 4391	FET	E25
L4(p)	Phi	BAT 54	Diode	E25	LT	Say	2SD2028	Trans.	E25	M63	Phi, Val(+)	PMBF 4392	FET	E25
L4	Say	2SC2812-L4	Trans.	E25	LT	Mat	2SD814A-T	Trans.	E25	M64	Phi, Val(+)	PMBF 4393	FET	E25
L4	Fer	BFS 37A	Trans.	E26	LT	Mat	2SD1821A-T	Trans.	E26	M65	Phi	BF 545A	FET	E25
L5	Fer	BSS 69R	Trans.	E25	LT	Mat	2SD2240A-T	Trans.	E40	M66	Phi	BF 545B	FET	E25
L5	Nip	2SC1623-L5	Trans.	E25	LY	Say	2SC4003	Trans.	E25	M67	Phi	BF 545C	FET	E25
L5	Say	2SC2812-L5	Trans.	E25	LY	Say	2SC3772	Trans.	E25	MA	Sie	BFS 17	Trans.	E25
L5	Fer	BFT 27	Trans.	E26	LY	Tos	2SC2712-Y	Trans.	E25	MA	Tos	2SC4392	Trans.	E26
L5p	Phi	BAS 55	Diode	E25	LY	Tos	2SC4116-Y	Trans.	E26	MA	Tos	2SC3011	Trans.	E25
L6	Fer	BSS 70R	Trans.	E25	LY	Tos	2SC4738-Y	Trans.	E40	MA	Mat	MA 151A	Diode	E25
L6	Nip	2SC1623-L6	Trans.	E25	M	Say	2SA1622	Trans.	E26	MA	Mat	MA 141A	Diode	E26
L6	Sie	BAR 17	Diode	E25	M	Say	SB 01W05C	Diode	E25	MB	Hit	2SA1052-B	Trans.	E25
L6	Say	2SC2812-L6	Trans.	E25	M1(p)	Phi, Mot, Tho	BFR 30	FET	E25	MB	Tos	2SC3098	Trans.	E25
L6	Fer	BSS 47	Trans.	E26	M1C	Mat	MA 158	Diode	E25	MB	Mat	MA 132A	Diode	E40
L7	Nip	2SC1623-L7	Trans.	E25	M1K	Mat	MA 704	Diode	E25	MB	Mat	MA 152A	Diode	E25
L7	Sie	BAR 14-1	Diode	E25	M1L	Mat	MA 704A	Diode	E25	MB	Mat	MA 142A	Diode	E26
L7	Say	2SC2812-L7	Trans.	E25	M1L	Mat	MA 741	Diode	E26	MC	Sie	BFS 17P	Trans.	E25
L7	Fer	BSS 56	Trans.	E26	M1L	Mat	MA 781	Diode	E40	MC	Hit	2SA1052-C	Trans.	E25
L8	Sie	BAR 15-1	Diode	E25	M1M	Mat	MA 721	Diode	E25					

Code	Herst.	Typ	Art	Fig.	Code	Herst.	Typ	Art	Fig.	Code	Herst.	Typ	Art	Fig.
MC	Tos	2SC3099	Trans.	E25	N13	Tho	SO2222	Trans.	E25	p1K	Phi	PMBT6428	Trans.	E25
MC	Mat	MA143	Diode	E26	N14	Say	2SK334-N14	FET	E25	p1L	Phi	PMBT6429	Trans.	E25
MC	Mat	MA153	Diode	E25	N17	Tho	SO1613	Trans.	E25	p1M	Phi	PMBTA13	Trans.	E25
MD	Hit	2SA1052-D	Trans.	E25	N18	Tho	SO1711	Trans.	E25	p1N	Phi	PMBTA14	Trans.	E25
MD	Mat	MA28-A	Diode	E25	N20	Tho	SO2222A	Trans.	E25	p1P	Phi	PMBT2222A	Trans.	E25
MD	Tos	2SA1245	Trans.	E25	N27	Tho	SO1893	Trans.	E25	p1Q	Phi	PMBT5088	Trans.	E25
ME	Mat	MA28-B	Diode	E25	N28	Tho	SO3572	Trans.	E25	P1Y	Phi	PMBT3903	Trans.	E25
ME	Tos	2SC4393	Trans.	E26	N44	Tho	SO3571	Trans.	E25	P2(p)	Sie,Aeg,Tho	BFR92A	Trans.	E25
ME	Tos	2SC3429	Trans.	E25	N47	Tho	SO3570	Trans.	E25	Mot				E25
ME	Mit	2SA1235-E	Trans.	E25	N54	Tho	SO2221A	Trans.	E25	P2	Fer	BFS43	Trans.	E26
ME	Mit	2SA1602-E	Trans.	E26	N66	Tho	SO269	Trans.	E25	p2A	Phi	PMBT3906	Trans.	E25
MF	Mat	MA28W-A	Diode	E25	N71	Tho	SO3904	Trans.	E25	p2B	Phi	PMBT2907	Trans.	E25
MF	Tos	2SC3445	Trans.	E25	N72	Tho	SO3903	Trans.	E25	p2D	Phi	PMBTA92	Trans.	E25
MF	Mit	2SA1235-F	Trans.	E25	N79	Tho	SO5550	Trans.	E25	p2E	Phi	PMBTA93	Trans.	E25
MF	Mit	2SA1602-F	Trans.	E26	N80	Tho	SO5551	Trans.	E25	p2F	Phi	PMBT2907A	Trans.	E25
MG	Mit	2SA1235-G	Trans.	E25	N81	Tho	SO2369A	Trans.	E25	p2G	Phi	PMBTA56	Trans.	E25
MG	Mit	2SA1602-G	Trans.	E26	N87	Tho	SO502S	Trans.	E25	p2H	Phi	PMBTA55	Trans.	E25
MH	Tos	2SC4394	Trans.	E26	N88	Tho	SO970	Trans.	E25	p2L	Phi	PMBT5401	Trans.	E25
MH	Tos	2SC3606	Trans.	E25	N81	Tho	SO642	Trans.	E25	p2T	Phi	PMBT4403	Trans.	E25
MH	Mat	MA151K	Diode	E25	N94	Tho(+)	SO517	Trans.	E25	p2U	Phi	PMBTA63	Trans.	E25
MH	Mat	MA141K	Diode	E26	NA	Sie,Aeg	BFS20	Trans.	E25	p2V	Phi	PMBTA64	Trans.	E25
MI	Mat	MA132K	Diode	E40	NB	Sie,Aeg,Tho	BF599	Trans.	E25	p2X	Phi	PMBT4401	Trans.	E25
MI	Mat	MA152K	Diode	E25	NCp	Phi	BF840	Trans.	E25	P03	Tho	SO2907A	Trans.	E25
MI	Mat	MA142K	Diode	E26	ND	Hit	2SD1306-D	Trans.	E25	P3	Fer	BFS44	Trans.	E26
MK	Mat	MA28W-B	Diode	E25	NDp	Phi	BF841	Trans.	E25	P4	Val,Aeg,Tho	BFR92R	Trans.	E25
ML	Mat	MA28T-A	Diode	E25	NE	Hit	2SD1306-E	Trans.	E25	Mot				E25
ML	Say	2SA1519	Trans.	E25	NL	Say	2SA1520	Trans.	E25	P4	Say	2SD1161-P4	Trans.	E25
MM	Mat	MA28T-B	Diode	E25	NO	Tos	2SC3138-O	Trans.	E25	P4	Fer	BFS45	Trans.	E26
MN	Tos	2SC4317	Trans.	E25	NO5	Tho	SO2484	Trans.	E25	P5	Fer	FMMT2369A	Trans.	E25
MN	Mat	MA151WA	Diode	E25	NO8	Tho	SO930	Trans.	E25	P5	Val,Aeg,Tho	BFR92AR	Trans.	E25
MN	Mat	MA141WA	Diode	E26	NR	Mat	2SD1679-R	Trans.	E25	Mot				E25
MO	Tos	2SC4322	Trans.	E25	NS	Mat	2SD1679-S	Trans.	E25	P5	Say	2SD1161-P5	Trans.	E25
MO	Tos	2SA1255-O	Trans.	E25	NT	Say	2SC4362	Trans.	E25	P05	Tho	SO2907	Trans.	E25
MO	Mat	MA132WA	Diode	E40	NT	Mat	2SD1679-T	Trans.	E25	p5A	Phi	PMBD6050	Diode	E25
MO	Mat	MA152WA	Diode	E25	NY	Say	2SC4004	Trans.	E25	p5B	Phi	PMBD6100	Diode	E25
MO	Mat	MA142WA	Diode	E26	NY	Say	2SC3774	Trans.	E25	p5C	Phi	PMBD7000	Diode	E25
MP	Tos	2SC4470	Trans.	E25	NY	Tos	2SC3138-Y	Trans.	E25	p5D	Phi	PMBD914	Diode	E25
MP	Mat	MA133	Diode	E40	NZ	Sie	BFS20R	Trans.	E25	P6	Say	2SD1161-P6	Trans.	E25
MP	Mat	MA143A	Diode	E26	O2	Val	BST82	FET	E25	P06	Tho	SO2894	Trans.	E25
MP	Mat	MA153A	Diode	E25	O4	Say	2SA1331-4	Trans.	E25	p6G	Phi	PMBF4393	FET	E25
MR	Mat	MA157	Diode	E25	O05	Tho	SO2484R	Trans.	E25	p6J	Phi	PMBF4391	FET	E25
MS	Mat	MA147	Diode	E26	O5	Say	2SA1331-5	Trans.	E25	p6K	Phi	PMBF4392	FET	E25
MS	Mat	MA157A	Diode	E25	O6	Say	2SA1331-6	Trans.	E25	p6S	Phi	PMBFJ176	FET	E25
MT	Say	2SC4360	Trans.	E25	O08	Tho	SO930R	Trans.	E25	p6W	Phi	PMBFJ175	FET	E25
MT	Mat	MA151WK	Diode	E25	O11	Tho	SO2369R	Trans.	E25	p6X	Phi	PMBFJ174	FET	E25
MT	Mat	MA141WK	Diode	E26	O12	Tho	SO2221R	Trans.	E25	p6Y	Phi	PMBFJ177	FET	E25
MU	Mat	MA132WK	Diode	E40	O13	Tho	SO2222R	Trans.	E25	p08	Phi	PMBFJ108	FET	E25
MU	Mat	MA152WK	Diode	E25	O17	Tho	SO1613R	Trans.	E25	P9	Fer	BCX70RK	Trans.	E25
MU	Mat	MA142WK	Diode	E26	O18	Tho	SO1711R	Trans.	E25	p09	Phi	PMBFJ109	FET	E25
MX	Mat	MA57	Diode	E25	O20	Tho	SO2222AR	Trans.	E25	p9A	Phi	PLVA650A	Diode	E25
MY	Say	2SC3773	Trans.	E25	O27	Tho	SO1893R	Trans.	E25	P9A	Phi	PMBS3904	Trans.	E25
MY	Tos	2SA1255-Y	Trans.	E25	O54	Tho	SO2221AR	Trans.	E25	p9B	Phi	PLVA653A	Diode	E25
MY	Mat	MA551	Diode	E25	O71	Tho	SO3904R	Trans.	E25	p9C	Phi	PLVA656A	Diode	E25
MZ	Sie	BFS17R	Trans.	E25	O72	Tho	SO3903R	Trans.	E25	p9D	Phi	PLVA659A	Diode	E25
MZ	Mat	MA370	Diode	E25	O79	Tho	SO5550R	Trans.	E25	p9E	Phi	PLVA662A	Diode	E25
N	Say	SB007T03C	Diode	E25	O80	Tho	SO5551R	Trans.	E25	p9F	Phi	PLVA665A	Diode	E25
N	Say	SB007T03Q	Diode	E26	O81	Tho	SO2369AR	Trans.	E25	p9G	Phi	PLVA668A	Diode	E25
N1	Val,Mul,Tho	BFR53	Trans.	E25	OL	Say	2SA1521	Trans.	E25	p10	Phi	PMBFJ110	FET	E25
N2	Mot,Nip	2SC1653-N2	Trans.	E25	OO	Tos	2SA1255-O	Trans.	E25	p11	Phi	PMBFJ111	FET	E25
		=MMBC1653N2	E25		OT	Say	2SC4364	Trans.	E25	P12	Tho	SO2906A	Trans.	E25
N3	Mot,Nip	2SC1653-N3	Trans.	E25	OT	Say	2SC4001	Trans.	E25	p12	Phi	PMBFJ112	FET	E25
		=MMBC1653N3	E25		OY	Say	2SC4005	Trans.	E25	p13	Phi	PMBFJ113	FET	E25
N4	Val,Mul,Tho	BFR53R	Trans.	E25	OY	Say	2SC3775	Trans.	E25	P18	Tho	SO679	Trans.	E25
N4	Mot,Nip	2SC1653-N4	Trans.	E25	OY	Tos	2SA1255-Y	Trans.	E25	P25	Tho	SO3906	Trans.	E25
		=MMBC1653N4	E25		P	Say	SB05W05C	Diode	E25	P26	Tho	SO3905	Trans.	E25
N5	Mot,Nip	2SC1654-N5	Trans.	E25	P1(p)	Phi,Aeg,Tho	BFR92	Trans.	E25	P32	Tho	SO5400	Trans.	E25
		=MMBC1654N5	E25		Mot				E25	P33	Tho	SO5401	Trans.	E25
N6	Mot,Nip	2SC1654-N6	Trans.	E25	P01	Tho	SO2906	Trans.	E25	P39	Tho	SO692	Trans.	E25
		=MMBC1654N6	E25		P1	Fer	BFS42	Trans.	E26	P40	Tho	SO506	Trans.	E25
N7	Mot,Nip	2SC1654-N7	Trans.	E25	p1A	Phi	PMBT3904	Trans.	E25	P41	Val	BFR92R	Trans.	E25
		=MMBC1654N7	E25		p1B	Phi	PMBT2222	Trans.	E25	PA	Sie	BA885	Diode	E25
N10	Tho	SO918	Trans.	E25	p1D	Phi	PMBTA42	Trans.	E25	PA	Tos	2SC3295-A	Trans.	E25
N11	Say	2SK334-N11	FET	E25	p1E	Phi	PMBTA43	Trans.	E25	PA	Tos	2SC4666A	Trans.	E26
N11	Tho	SO2369	Trans.	E25	p1F	Phi	PMBT5550	Trans.	E25	pA2	Phi	PMBD2836	Diode	E25
N12	Say	2SK334-N12	FET	E25	p1G	Phi	PMBTA06	Trans.	E25	pA3	Phi	PMBD2835	Diode	E25
N12	Tho	SO2221	Trans.	E25	p1H	Phi	PMBTA05	Trans.	E25	pA5	Phi	PMBD2837	Diode	E25
N13	Say	2SK334-N13	FET	E25	p1J	Phi	PMBT2369	Trans.	E25	pA6	Phi	PMBD2838	Diode	E25

Code	Herst.	Typ	Art	Fig.	Code	Herst.	Typ	Art	Fig.	Code	Herst.	Typ	Art	Fig.
PB	Tos	2SC3295-B	Trans.	E25	R05	Sam	KSR1105	Trans.	E25	S2	Hit	HSM112WK	Diode	E25
PB	Tos	2SC4668B	Trans.	E26	R6	Say	2SK283-R6	FET	E25	s2A	Sie	SMBT3906	Trans.	E25
PC	Sie	BA886	Diode	E25	R06	Sam	KSR1106	Trans.	E25	s2B	Sie	SMBT2907	Trans.	E25
PD	Hit	2SA1171-D	Trans.	E25	R07	Sam	KSR1107	Trans.	E25	s2C	Sie	SMBTA-70	Trans.	E25
PE	Hit	2SA1171-E	Trans.	E25	R7	Phi,Sie	BFR106	Trans.	E25	s2D	Sie	SMBTA92	Trans.	E25
pGI	Phi	PMBT5551	Trans.	E25	R08	Sam	KSR1108	Trans.	E25	s2E	Sie	SMBTA93	Trans.	E25
PIB	Hit	2SK1070-B	FET	E25	R09	Sam	KSR1109	Trans.	E25	s2F	Sie	SMBT2907A	Trans.	E25
PIC	Hit	2SK1070-C	FET	E25	R10	Sam	KSR1110	Trans.	E25	s2G	Sie	SMBTA56	Trans.	E25
PID	Hit	2SK1070-D	FET	E25	R11	Sam	KSR1111	Trans.	E25	s2H	Sie	SMBTA55	Trans.	E25
PIE	Hit	2SK1070-E	FET	E25	R12	Sam	KSR1112	Trans.	E25	s2O	Sie	SMBT5087	Trans.	E25
pKX	Phi	PMBF170	FET	E25	R22	Nip	2SC3356	Trans.	E25	s2P	Sie	SMBT5086	Trans.	E25
PL	Say	2SB1234	Trans.	E25	R51	Sam	KSR2101	Trans.	E25	s2U	Sie	SMBTA63	Trans.	E25
PN	Aeg	BA779	Diode	E25	R52	Sam	KSR2102	Trans.	E25	s2V	Sie	SMBTA64	Trans.	E25
PO	Tos	2SA1712-O	Trans.	E25	R53	Sam	KSR2103	Trans.	E25	S3	Tho,Fer	BFQ31R	Trans.	E25
PO6	Phi	PMB53906	Trans.	E25	R54	Sam	KSR2104	Trans.	E25	S3	Nip	2SA813-S3	Trans.	E25
PQ	Mat	2SD814-Q	Trans.	E25	R55	Sam	KSR2105	Trans.	E25	S3	Fer	BSV36	Trans.	E26
PQ	Mat	2SD1821-Q	Trans.	E26	R56	Sam	KSR2106	Trans.	E25	S3 0	Phi(+)	BB8040	Diode	E25
PQ	Mat	2SD2240-Q	Trans.	E40	R57	Sam	KSR2107	Trans.	E25	S3 1	Phi(+)	BB8041	Diode	E25
PR	Tos	2SA1712-R	Trans.	E25	R58	Sam	KSR2108	Trans.	E25	S3 2	Phi(+)	BB8042	Diode	E25
PR	Mat	2SD814-R	Trans.	E25	R59	Sam	KSR2109	Trans.	E25	S3 3	Phi(+)	BB8043	Diode	E25
PR	Mat	2SD1821-R	Trans.	E26	R60	Sam	KSR2110	Trans.	E25	S3 4	Phi(+)	BB8044	Diode	E25
PR	Mat	2SD2240-R	Trans.	E40	R61	Sam	KSR2111	Trans.	E25	S4	Tho,Fer	BFQ31A	Trans.	E25
PS	Mat	2SD814-S	Trans.	E25	R62	Sam	KSR2112	Trans.	E25	S4	Nip	2SA813-S4	Trans.	E25
PS	Mat	2SD1821-S	Trans.	E26	RA	Sie	BFQ81	Trans.	E25	S4	Say	2SC3361-S4	Trans.	E25
PS	Mat	2SD2240-S	Trans.	E40	RAO	Tos	2SC3718-O	Trans.	E25	S4	Fer	BSV37	Trans.	E26
PT	Say	2SC4365	Trans.	E25	RAY	Tos	2SC3718-Y	Trans.	E25	S5	Tho,Fer	BFQ31AR	Trans.	E25
PT	Say	2SC4002	Trans.	E25	RB	Hit	2SC2618-B	Trans.	E25	S5	Say	2SC3361-S5	Trans.	E25
PT	Mat	2SD814-T	Trans.	E25	RB	Sie	BF771	Trans.	E25	S5	Hit	HRW0203A	Diode	E25
PT	Mat	2SD1821-T	Trans.	E26	RBG	Tos	2SK711-GR	FET	E25	S5A, s5A	Sie	SMBD6050	Diode	E25
PT	Mat	2SD2240-T	Trans.	E40	RBL	Tos	2SK711-BL	FET	E25	S5B, s5B	Sie	SMBD6100	Diode	E25
PY	Say	2SC3859	Trans.	E25	RBV	Tos	2SK711-V	FET	E25	S5C, s5C	Sie	SMBD7000	Diode	E25
Q	Say	SB05-03C	Diode	E25	RC	Hit	2SC2618-C	Trans.	E25	S5D, s5D	Sie	SMBD914	FET	E25
Q	Say	SB05-03Q	Diode	E26	RC(s)	Sie	BFR193	Trans.	E25	S6(p)	Phi	BF510	FET	E25
Q2	Mot,Nip	2SC1321-Q2	Trans.	E25	RD	Hit	2SC2618-D	Trans.	E25	S6	Say	2SC3361-S6	Trans.	E25
		=MMBC1321Q2		E25	RDs	Sie	BFR180	Trans.	E25	S6	Hit	HRW0503A	Diode	E25
Q2	Say	2SC2813-Q2	Trans.	E25	RE	Rhm	2SA1514K-E	Trans.	E25	S7(p)	Phi	BF511	FET	E25
Q3	Mot,Nip	2SC1321-Q3	Trans.	E25	RE	Rhm	2SA1579-E	Trans.	E26	S7	Hit	HSM109WK	Diode	E25
		=MMBC1321Q3		E25	REs	Sie	BFR280	Trans.	E25	S8(p)	Phi	BF512	FET	E25
Q3	Say	2SC2813-Q3	Trans.	E25	RFs	Sie	BFR181	Trans.	E25	S9(p)	Phi	BF513	FET	E25
Q4	Mot,Nip	2SC1321-Q4	Trans.	E25	RGs	Sie	BFR182	Trans.	E25	S11	Hit	HRW0302A	Diode	E25
		=MMBC1321Q4		E25	RHs	Sie	BFR183	Trans.	E25	S12	Phi	BBY39	Diode	E25
Q4	Say	2SA1331-Q4	Trans.	E25	RKs	Sie	BFR194	Trans.	E25	S12	Hit	HSM113WK	Diode	E25
Q4	Say	2SC2813-Q4	Trans.	E25	RL	Say	2SA1563	Trans.	E25	S13	Phi	BBY42	Diode	E25
Q5	Mot,Nip	2SC1321-Q5	Trans.	E25	RO	Tos	2SC2715-O	Trans.	E25	S14	Phi	BB901	Diode	E25
		=MMBC1321Q5		E25	RR	Tos	2SC2715-R	Trans.	E25	SA	Sie,Val	BSS123	FET	E25
Q5	Say	2SA1331-Q5	Trans.	E25	RR	Rhm	2SA1514K-R	Trans.	E25	SA	Sie(+)	SMBTA20	Trans.	E25
Q5	Say	2SC2813-Q5	Trans.	E25	RR	Rhm	2SA1579-R	Trans.	E26	SA2, sA2	Sie	SMBD2836	Diode	E25
Q6	Say	2SA1331-Q6	Trans.	E25	RS	Rhm	2SA1514K-S	Trans.	E25	SA3, sA3	Sie	SMBD2835	Diode	E25
QA	Hit	2SC2620-A	Trans.	E25	RS	Rhm	2SA1579-S	Trans.	E26	SA4, sA4	Sie	SMBD2838	Diode	E25
QB	Hit	2SC2620-B	Trans.	E25	RS	Mat	2SC2480-S	Trans.	E25	SA5, sA5	Sie	SMBD2837	Diode	E25
QC	Hit	2SC2620-C	Trans.	E25	RS	Mat	2SC3932-S	Trans.	E26	SAs	Sie	BSS123	FET	E25
QI	Hit	2SC4196	Trans.	E25	RT	Say	2SC4400	Trans.	E26	SB	Hit	2SA1121-B	Trans.	E25
QI	Hit	2SC4261	Trans.	E26	RT	Say	2SC4000	Trans.	E25	SB	Sie(+)	SMBT2222	Trans.	E25
QL	Say	2SA1580	Trans.	E25	RT	Say	2SC4432	Trans.	E25	SC	Hit	2SA1121-C	Trans.	E25
QO	Tos	2SC4215-O	Trans.	E26	RT	Mat	2SC2480-T	Trans.	E25	SC	Sie(+)	SMBT2222A	Trans.	E25
QO	Tos	2SC2714-O	Trans.	E25	RT	Mat	2SC3932-T	Trans.	E26	sC3	Sie	SMBT4126	Trans.	E25
QR	Tos	2SC4215-R	Trans.	E26	RY	Say	2SC3898	Trans.	E25	SD	Hit	2SA1121-D	Trans.	E25
QR	Tos	2SC2714-R	Trans.	E25	RY	Tos	2SC2715-Y	Trans.	E25	SD	Sie(+)	SMBT2907	Trans.	E25
QT	Say	2SC4412	Trans.	E25	S1(p)	Phi,Val	BBY31	Diode	E25	SD	Sie	BSS145	FET	E25
QY	Say	2SC4498	Trans.	E26	S1	Fer	BSV35A	Trans.	E26	SE	Sie(+)	SMBT2907A	Trans.	E25
QY	Say	2SC3863	Trans.	E25	s1A	Sie	SMBT3904	Trans.	E25	SF	Sie	BB804	Diode	E25
QY	Tos	2SC4215-Y	Trans.	E26	s1B	Sie	SMBT2222	Trans.	E25	SF	Sie(+)	SMBTA13	Trans.	E25
QY	Tos	2SC2714-Y	Trans.	E25	s1C	Sie	SMBTA20	Trans.	E25	SF0	Sie	BB8040	Diode	E25
R1(p)	Phi,Aeg,Tho	BFR93	Trans.	E25	s1D	Sie	SMBTA42	Trans.	E25	SF1	Sie	BB8041	Diode	E25
	Mot			E25	s1E	Sie	SMBTA43	Trans.	E25	SF2	Sie	BB8042	Diode	E25
R01	Sam	KSR1101	Trans.	E25	s1G	Sie	SMBTA06	Trans.	E25	SF3	Sie	BB8043	Diode	E25
R2(p)	Phi,Aeg,Tho	BFR93A	Trans.	E25	s1H	Sie	SMBTA05	Trans.	E25	SF4	Sie	BB8044	Diode	E25
R2	Nip	2SC2351-R2	Trans.	E25	s1K	Sie	SMBT6428	Trans.	E25	SG	Tos	2SA1162-GR	Trans.	E25
R02	Sam	KSR1102	Trans.	E25	s1L	Sie	SMBT6429	Trans.	E25	SG	Sie(+)	SMBTA14	Trans.	E25
R3	Nip	2SC2351-R3	Trans.	E25	s1M	Sie	SMBTA13	Trans.	E25	SG	Tos	2SA1586-G	Trans.	E26
R3	Say	2SK283-R3	FET	E25	s1N	Sie	SMBTA14	Trans.	E25	SG	Tos	2SA1832-G	Trans.	E40
R03	Sam	KSR1103	Trans.	E25	s1P	Sie	SMBTA2222A	Trans.	E25	SH	Sie	BB814	Diode	E25
R4	Val,Aeg,Tho	BFR93R	Trans.	E25	s1V	Sie	SMBT6427	Trans.	E25	SH1	Sie	BB8141	Diode	E25
R4	Say	2SK283-R4	FET	E25	S2	Tho,Fer	BFQ31	Trans.	E25	SH2	Sie	BB8142	Diode	E25
R04	Sam	KSR1104	Trans.	E25	S2	Nip	2SA813-S2	Trans.	E25	SJ	Sie(+)	SMBTA92	Trans.	E25
R5	Val,Aeg,Tho	BFR93AR	Trans.	E25	S2	Val	BBY40	Diode	E25	SK	Sie(-)	SMBTA93	Trans.	E25
R5	Say	2SK283-R5	FET	E25	S2	Fer	BSV35	Trans.	E26	SL	Say	2SA1571	Trans.	E25

Code	Herst.	Typ	Art	Fig.	Code	Herst.	Typ	Art	Fig.	Code	Herst.	Typ	Art	Fig.
SL	Sie (+)	SMBTA 42	Trans.	E25	T92	Phi	BSR 18A	Trans.	E25	UF	Sie	BB 801	Diode	E25
SM	Sie (+)	SMBTA 43	Trans.	E25	T93	Phi	BSR 18AR	Trans.	E25	UG	Sie.Tho	BBY 31	Diode	E25
SM	Rhm	2SC3082K-M	Trans.	E25	TA	Sie	KTY 13-A	Sensor	E25	UI	Hit	2SC4229	Trans.	E25
SM	Rhm	2SC4100-M	Trans.	E26	TB	Sie	KTY 13-B	Sensor	E25	UI	Hit	2SC4259	Trans.	E26
SN	Sie (+)	SMBT 3904	Trans.	E25	TC	Hit	2SC2736	Trans.	E25	UL	Say	2SB1295	Trans.	E25
SN	Rhm	2SC3082K-N	Trans.	E25	TC	Sie	KTY 13-C	Sensor	E25	UT	Say	2SC4555	Trans.	E26
SN	Rhm	2SC4100-N	Trans.	E26	TD	Sie	KTY 13-D	Sensor	E25	UT	Say	2SC4577	Trans.	E25
SO	Tos	2SA1162-O	Trans.	E25	TE	Rhm	2SC3906K-E	Trans.	E25	UY	Say	2SC3913	Trans.	E25
SO	Sie (+)	SMBT 3906	Trans.	E25	TE	Rhm	2SC4102-E	Trans.	E26	V	Say	2SK1332	FET	E26
SO	Tos	2SA1586-O	Trans.	E26	TF	Mot	BAL 99	Diode	E25	V1(p)	Phi	BFT 25	Trans.	E25
SO	Tos	2SA1832-O	Trans.	E40	TG	Tos	2SK302-GR	FET	E25	V1	Nip	2SD596-V1	Trans.	E25
SP	Sie	BSS 84	FET	E25	TG	Tos	2SK882-GR	FET	E26	V2(p)	Phi	BFQ 67	Trans.	E25
SP	Rhm	2SC3082K-P	Trans.	E25	TI	Hit	2SC4197	Trans.	E25	V2	Nip	2SD596-V2	Trans.	E25
SP	Rhm	2SC4100-P	Trans.	E26	TI	Hit	2SC4260	Trans.	E26	V2	Say	2SK303-V2	FET	E25
SPs	Sie	BSS 84	FET	E25	TL	Say	2SA1573	Trans.	E25	V3	Nip	2SD596-V3	Trans.	E25
SQ	Rhm	2SC3082K-Q	Trans.	E25	TO	Tos	2SK302-O	FET	E25	V3	Say	2SK303-V3	FET	E25
SQ	Rhm	2SC4100-Q	Trans.	E26	TQ	Mit	2SA1530-Q	Trans.	E25	V3	Tos	1SV225	Diode	E25
SR	Sie,Val	BSS 131	FET	E25	TQ	Mit	2SA1603-Q	Trans.	E26	V4	Val	8FT 25R	Trans.	E25
SR	Mat	2SC2405-R	Trans.	E25	TR	Mit	2SA1530-R	Trans.	E25	V4	Nip	2SD780-V4	Trans.	E25
SR	Mat	2SC3929-R	Trans.	E26	TR	Mit	2SA1603-R	Trans.	E26	V4	Say	2SK303-V4	FET	E25
SRs	Sie	BSS 131	FET	E25	TR	Rhm	2SC3906K-R	Trans.	E25	V4	Tos	1SV228	Diode	E25
SS	Sie,Val	BSS 138	FET	E25	TR	Rhm	2SC4102-R	Trans.	E26	V5	Nip	2SD780-V5	Trans.	E25
SS	Mat	2SC2405-S	Trans.	E25	TR	Mat	2SC2406-R	Trans.	E25	V5	Say	2SK303-V5	FET	E25
SS	Mat	2SC3929-S	Trans.	E26	TR	Mat	2SC3929A-R	Trans.	E26	V6	Nip	2SD780-V6	Trans.	E25
(s)SF	Sie	SP 0610T	FET	E25	TS	Mit	2SA1530-S	Trans.	E25	V10	Phi	BFT 25A	Trans.	E25
(S)SG	Sie	SN 7002	FET	E25	TS	Mit	2SA1603-S	Trans.	E26	VA	Hit	2SC2776-A	Trans.	E25
(s)SH	Sie	BSS 119	FET	E25	TS	Rhm	2SC3906K-S	Trans.	E25	VA	Mat	2SC2295-A	Trans.	E25
SSs	Sie	BSS 138	FET	E25	TS	Rhm	2SC4102-S	Trans.	E26	VA	Mat	2SC3930-A	Trans.	E26
ST	Say	2SC4452	Trans.	E26	TS	Mat	2SC2406-S	Trans.	E25	VA	Mat	2SC4626-A	Trans.	E40
ST	Say	2SC4453	Trans.	E25	TS	Mat	2SC3929A-S	Trans.	E26	VB	Hit	2SC2776-B	Trans.	E25
ST	Mat	2SC2405-T	Trans.	E25	TT	Say	2SC4519	Trans.	E25	VB	Mat	2SC2295-B	Trans.	E25
ST	Mat	2SC3929-T	Trans.	E26	TT	Mit	2SA1530-T	Trans.	E25	VB	Mat	2SC3930-B	Trans.	E26
ST(s)	Sie	BSS 139	FET	E25	TT	Mit	2SA1603-T	Trans.	E26	VB	Mat	2SC4626-B	Trans.	E40
SY	Say	2SC3900	Trans.	E25	TT	Mat	2SC2406-T	Trans.	E25	VC	Hit	2SC2776-C	Trans.	E25
SY	Tos	2SA1162-Y	Trans.	E25	TT	Mat	2SC3929A-T	Trans.	E26	VC	Mat	2SC2295-C	Trans.	E25
SY	Tos	2SA1586-Y	Trans.	E26	TY	Say	2SC3912	Trans.	E25	VC	Mat	2SC3930-C	Trans.	E26
SY	Tos	2SA1832-Y	Trans.	E40	TY	Tos	2SK882-Y	FET	E26	VC	Mat	2SC4626-C	Trans.	E40
sZC	Sie	SMBT 4124	Trans.	E25	TY	Tos	2SK302-Y	FET	E25	VG	Tos	2SJ106-GR	FET	E25
T1(p)	Phi,Mot,Fer	BCX 17	Trans.	E25	TZ	Sie	BZW 20	Kombi	E25	VG	Tos	2SJ144-GR	FET	E26
T1	Hit	HVM 89	Diode	E25	U1(p)	Phi,Fer,Mot	BCX 19	Trans.	E25	VI	Tos	1SV160	Diode	E25
T2(p)	Phi,Mot,Fer	BCX 18	Trans.	E25	U2(p)	Phi,Fer,Mot	BCX 20	Trans.	E25	VIB	Hit	2SA1617-B	Trans.	E25
T2	Say	2SK242-T2	FET	E25	U3	Val,Tho,Fer	BSS 84	Trans.	E25	VIC	Hit	2SA1617-C	Trans.	E25
T2	Hit	HVM 15	Diode	E25	U4	Val,Fer	BCX 19R	Trans.	E25	VL	Say	2SA1581	Trans.	E25
T3	Say	2SK1065-3	FET	E26	U5	Val,Fer	BCX 20R	Trans.	E25	VL	Tos	2SJ106-BL	FET	E25
T3	Val,Tho,Fer	BSS 63	Trans.	E25	U6	Val,Tho,Fer	BSS 64R	Trans.	E25	VL	Tos	2SJ144-BL	FET	E26
T3	Say	2SK242-T3	FET	E25	U7(p)	Phi,Tho	BSR 13	Trans.	E25	VY	Say	2SC3914	Trans.	E25
T3	Hit	HVM 16	Diode	E25	U8(p)	Phi,Tho	BSR 14	Trans.	E25	VY	Tos	2SJ106-Y	FET	E25
T4	Val,Fer	BCX 17R	Trans.	E25	U9	Phi	BSR 17	Trans.	E25	VY	Tos	2SJ144-Y	FET	E26
T4	Say	2SK242-T4	FET	E25	U12	Nip	2SC2758-U12	Trans.	E25	W1(p)	Phi,Sie	BFT 92	Trans.	E25
T4	Say	2SK1065-4	FET	E26	U13	Nip	2SC2758-U13	Trans.	E25	W1	Say	DSA 010	Diode	E25
T4	Hit	HVM 11	Diode	E25	U14	Nip	2SC2758-U14	Trans.	E25	W2	Sie	BZX 84/C0V8	Stabi	E25
T5	Val,Fer	BCX 18R	Trans.	E25	U21	Nip	2SC2759-U21	Trans.	E25	W2	Say	DSB 010	Diode	E25
T5	Say	2SK242-T5	FET	E25	U22	Nip	2SC2759-U22	Trans.	E25	W3	Sie	BZX 84/C2V4	Z-Di.	E25
T5	Say	2SK1065-5	FET	E26	U23	Nip	2SC2759-U23	Trans.	E25	W3	Say	DSC 010	Diode	E25
T6	Val,Tho,Fer	BSS 63R	Trans.	E25	U35	Phi	BSR 19	Trans.	E25	W4	Sie	BZX 84/C2V7	Z-Di.	E25
T6	Hit	HVM 17	Diode	E25	U36	Phi	BSR 19A	Trans.	E25	W4	Val	BFT 92R	Trans.	E25
T7(p)	Phi,Tho	BSR 15	Trans.	E25	U71	Phi,Tho	BSR 13R	Trans.	E25	W4	Fer	BZX88C2V7	Z-Di	E26
T8(p)	Phi,Tho	BSR 16	Trans.	E25	U81	Phi,Tho	BSR 14R	Trans.	E25	W4	Say	DSD 010	Diode	E25
T8	Hit	HVM 25	Diode	E25	U91	Phi	BSR 17R	Trans.	E25	W5	Sie	BZX 84/C3V0	Z-Di.	E25
T9	Val	BSR 18	Trans.	E25	U92	Phi	BSR 17A	Trans.	E25	W5	Fer	BZX88C3V0	Z-Di	E26
T9	Hit	HVM 306	Diode	E25	U93	Phi	BSR 17AR	Trans.	E25	W5	Say	DCA 010	Diode	E25
T12	Nip	2SC2755-T12	Trans.	E25	UA	Rhm	2SB852K-A	Trans.	E25	W5	Say	DCF 010	Diode	E26
T13	Nip	2SC2755-T13	Trans.	E25	UB	Sie,Tho	BB 503	Diode	E25	W6	Sie	BZX 84/C3V3	Z-Di.	E25
T14	Nip	2SC2755-T14	Trans.	E25	UB	Rhm	2SB852K-B	Trans.	E25	W6	Fer	BZX88C3V3	Z-Di	E26
T22	Nip	2SC2756-T22	Trans.	E25	UB	Mat	2SC2404-B	Trans.	E25	W6	Say	DCB 010	Diode	E25
T23	Nip	2SC2756-T23	Trans.	E25	UB	Mat	2SC3931-B	Trans.	E26	W6	Say	DCC 010	Say	E26
T24	Nip	2SC2756-T24	Trans.	E25	UB	Mat	2SC4627-B	Trans.	E40	W7	Sie	BZX 84/C3V6	Z-Di.	E25
T32	Nip	2SC2757-T32	Trans.	E25	UC	Mat	2SC2404-C	Trans.	E25	W7	Fer	BZX88C3V6	Z-Di	E26
T33	Nip	2SC2757-T33	Trans.	E25	UC	Mat	2SC3931-C	Trans.	E26	W7	Say	DCC 010	Diode	E25
T34	Nip	2SC2757-T34	Trans.	E25	UC	Mat	2SC4627-C	Trans.	E40	W8	Sie	BZX 84/C3V9	Z-Di.	E25
T35	Phi	BSR 20	Trans.	E25	UD	Sie,Tho	BB 504	Diode	E25	W8	Fer	BZX88C3V9	Z-Di	E26
T36	Phi	BSR 20A	Trans.	E25	UD	Hit	2SC2821-D	Trans.	E25	W9	Sie	BZX 84/C4V3	Z-Di.	E25
T71	Phi,Tho	BSR 15R	Trans.	E25	UD	Mat	2SC2404-D	Trans.	E25	W9	Fer	BZX88C4V3	Z-Di	E26
T81	Phi,Tho	BSR 16R	Trans.	E25	UD	Mat	2SC3931-D	Trans.	E26	W9	Say	DPA 05	Diode	E25
T91	Phi	BSR 18R	Trans.	E25	UD	Mat	2SC4627-D	Trans.	E40	WA	Rhm	2SD1383K-A	Trans.	E25
					UE	Hit	2SC2821-E	Trans.	E25	WB	Rhm	2SD1383K-B	Trans.	E25
					UF	Hit	2SC2821-F	Trans.	E25	WCs	Sie	BCR 133	Trans.	E25

Code	Herst.	Typ	Art	Fig.	Code	Herst.	Typ	Art	Fig.	Code	Herst.	Typ	Art	Fig.
1BG	Tos	2SC3340-GR	Trans.	E25	1OR	Mat	2SK198-R	FET	E25	2FS	Mat	2SB792A-S	Trans.	E25
1BL	Tos	2SC3340-BL	Trans.	E25	1OR	Mat	2SK662-R	FET	E26	2G	Fer	FMMT-A56	Trans.	E25
1BR	Sie,Phi	BC846BR	Trans.	E25	1P	Fer	FMMT2222A	Trans.	E25	2G(p.s)	Sie,Phi	BC 850C	Trans.	E25
1C	Fer	FMMT-A20	Trans.	E25	1P	Mot	MMBT2222A	Trans.	E25	2G	Mot	MMBT A56	Trans.	E25
1C	Mot, Sam	MMBT A20	Trans.	E25	1Q	Mot	MMBT5088	Trans.	E25	2GR	Sie, Val	BC 850CR	Trans.	E25
1CL	Rhm	2SC4082-L	Trans.	E26	1R	Mot	MMBT5089	Trans.	E25	2GT	Tho	SOA 56	Trans.	E25
1CM	Rhm	2SC4082-M	Trans.	E26	1RQ	Mat	2SB970-Q	Trans.	E25	2H	Fer	FMMT-A55	Trans.	E25
1CN	Rhm	2SC4082-N	Trans.	E26	1RR	Mat	2SB970-R	Trans.	E25	2H	Mot	MMBT A55	Trans.	E25
1CO	Tos	2SC3341-O	Trans.	E25	1RS	Mat	2SB970-S	Trans.	E25	2H(p)	Phi	BC 850	Trans.	E25
1CP	Rhm	2SC4082-P	Trans.	E26	1SP	Mat	2SC3130-P	Trans.	E25	2HT	Tho	SOA 55	Trans.	E25
1CQ	Rhm	2SC4082-Q	Trans.	E26	1SP	Mat	2SC3935-P	Trans.	E26	2J	Mot	MMBT3640	Trans.	E25
1CY	Tos	2SC3341-Y	Trans.	E25	1SQ	Mat	2SC3130-Q	Trans.	E25	2L	Mot	MMBT5401	Trans.	E25
1D	Mot	MMBT A42	Trans.	E25	1SQ	Mat	2SC3935-Q	Trans.	E26	2M	Fer	FMMT5087	Trans.	E25
1D(p)	Phi	BC 846	Trans.	E25	1SR	Mat	2SC3130-R	Trans.	E25	2M	Mot	MMBT404	Trans.	E25
1DL	Rhm	2SC4083-L	Trans.	E26	1SR	Mat	2SC3935-R	Trans.	E26	2N	Mot	MMBT404A	Trans.	E25
1DM	Rhm	2SC4083-M	Trans.	E26	1T	Mot	MMBT3960A	Trans.	E25	2NP	Mat	2SD1478-P	Trans.	E25
1DN	Rhm	2SC4083-N	Trans.	E26	1T	Mat	2SC3077	Trans.	E25	2NQ	Mat	2SD1478-Q	Trans.	E25
1DP	Rhm	2SC4083-P	Trans.	E26	1T	Mat	2SC3933	Trans.	E26	2NR	Mat	2SD1478-R	Trans.	E25
1DQ	Rhm	2SC4083-Q	Trans.	E26	1U	Mot	MMBT2484	Trans.	E25	2OP	Mat	2SD1478A-P	Trans.	E25
1DR	Mat	2SD1328-R	Trans.	E25	1U	Mat	2SC3110	Trans.	E25	2OQ	Mat	2SD1478A-Q	Trans.	E25
1DS	Mat	2SD1328-S	Trans.	E25	1U	Mat	2SC3934	Trans.	E26	2OR	Mat	2SD1478A-R	Trans.	E25
1DT	Mat	2SD1328-T	Trans.	E25	1V(p)	Phi	BF 820	Trans.	E25	2P	Fer	FMMT2222R	Trans.	E25
1E	Fer	FMMT-A43	Trans.	E25	1V	Mot	MMBT6427	Trans.	E25	2P	Mot	MMBT5086	Trans.	E25
1E(p.s)	Sie,Phi	BC 847A	Trans.	E25	1VR	Mat	2SD1149-R	Trans.	E25	2Q	Mot	MMBT5087	Trans.	E25
1E	Mot	MMBT A43	Trans.	E25	1VR	Mat	2SD1824-R	Trans.	E26	2R	Mot	MMBT4260	Trans.	E25
1EL	Rhm	2SC4084-L	Trans.	E26	1VS	Mat	2SD1149-S	Trans.	E25	2S	Mot	MMBT4261	Trans.	E25
1EM	Rhm	2SC4084-M	Trans.	E26	1VS	Mat	2SD1824-S	Trans.	E26	2T	Fer	HT 2	Trans.	E25
1EN	Rhm	2SC4084-N	Trans.	E26	1VT	Mat	2SD1149-T	Trans.	E25	2T	Tho	SO 4403	Trans.	E25
1EP	Rhm	2SC4084-P	Trans.	E26	1VT	Mat	2SD1824-T	Trans.	E26	2T	Mot, Sam	MMBT 4403	Trans.	E25
1EQ	Rhm	2SC4084-Q	Trans.	E26	1W(p)	Phi	BF 821	Trans.	E25	2U	Mot	MMBT A63	Trans.	E25
1ER	Sie,Phi	BC 847AR	Trans.	E25	1W	Fer	FMMT3903	Trans.	E25	2V	Mot	MMBT A64	Trans.	E25
1F(p.s)	Sie,Phi	BC 847B	Trans.	E25	1X(p)	Phi	BF 822	Trans.	E25	2W	Fer	FMMT3905	Trans.	E25
1F	Mot	MMBT5550	Trans.	E25	1X	Mat	2SC2845	Trans.	E25	2W	Mat	2SC3704	Trans.	E25
1FP	Mat	2SK321-P	FET	E25	1XB	Mat	2SC4780-B	Trans.	E26	2W	Mat	2SC3937	Trans.	E26
1FQ	Mat	2SK321-Q	FET	E25	1XC	Mat	2SC4780-C	Trans.	E26	2X	Tho	SO 4401	Trans.	E25
1FR	Sie,Phi	BC 847BR	Trans.	E25	1Y(p)	Phi	BF 823	Trans.	E25	2X	Mot, Sam	MMBT 4401	Trans.	E25
1FR	Mat	2SK321-R	FET	E25	1Y	Mot, Sam	MMBT 3903	Trans.	E25	2X	Mat	2SC3707	Trans.	E25
1FS	Mat	2SK321-S	FET	E25	1ZR	Mat	2SD1030-R	Trans.	E25	2X	Mat	2SC4410	Trans.	E26
1G	Fer	FMMT-A06	Trans.	E25	1ZR	Mat	2SD1823-R	Trans.	E26	2YQ	Mat	2SC3757-Q	Trans.	E25
1G(p.s)	Sie,Phi	BC 847C	Trans.	E25	1ZR	Mat	2SD2345-R	Trans.	E40	2YQ	Mat	2SC3938-Q	Trans.	E26
1G	Mot	MMBT A06	Trans.	E25	1ZS	Mat	2SD1030-S	Trans.	E25	2YQ	Mat	2SC4691-Q	Trans.	E40
1GR	Sie,Phi	BC 847CR	Trans.	E25	1ZS	Mat	2SD1823-S	Trans.	E26	2YR	Mat	2SC3757-R	Trans.	E25
1GT	Tho	SOA 06	Trans.	E25	1ZS	Mat	2SD2345-S	Trans.	E40	2YR	Mat	2SC3938-R	Trans.	E26
1H	Fer	FMMT-A05	Trans.	E25	1ZT	Mat	2SD1030-T	Trans.	E25	2YR	Mat	2SC4691-R	Trans.	E40
1H	Mot	MMBT A05	Trans.	E25	1ZT	Mat	2SD1823-T	Trans.	E26	2YS	Mat	2SC3757-S	Trans.	E25
1H(p)	Phi	BC 847	Trans.	E25	1ZT	Mat	2SD2345-T	Trans.	E40	2YS	Mat	2SC3938-S	Trans.	E26
1HT	Tho	SOA 05	Trans.	E25	02	Mot	BSX 39	Trans.	E25	2YS	Mat	2SC4691-S	Trans.	E40
1J	Fer	FMMT2369	Trans.	E25	2A	Fer	FMMT3906	Trans.	E25	2Z	Mat	2SC4417	Trans.	E26
1J(p.s)	Sie,Phi	BC 848A	Trans.	E25	2A	Mot	MMBT3906	Trans.	E25	3A(p.s)	Sie,Phi	BC 856A	Trans.	E25
1J	Mot	MMBT2369	Trans.	E25	2AQ	Mat	2SD1304-Q	Trans.	E25	3A	Mot	MMBT H24	Trans.	E25
1JR	Sie,Phi	BC 848AR	Trans.	E25	2AR	Mat	2SD1304-R	Trans.	E25	3AG	Tos	2SA1324-GR	Trans.	E25
1K(p.s)	Sie,Phi	BC 848B	Trans.	E25	2AS	Mat	2SD1304-S	Trans.	E25	3AO	Tos	2SA1324-O	Trans.	E25
1K	Mot	MMBT6428	Trans.	E25	2B	Fer	FMMT2907	Trans.	E25	3AR	Sie,Phi	BC 856AR	Trans.	E25
1KP	Mat	2SK316-P	FET	E25	2B(p.s)	Sie,Phi	BC 849B	Trans.	E25	3AY	Tos	2SA1324-Y	Trans.	E25
1KQ	Mat	2SK316-Q	FET	E25	2B	Mot	MMBT2907	Trans.	E25	3B	Fer	FMMT918	Trans.	E25
1KR	Sie,Phi	BC 848BR	Trans.	E25	2BP	Mat	2SK374-P	FET	E25	3B(p.s)	Sie,Phi	BC 856B	Trans.	E25
1L(p.s)	Sie,Phi	BC 848C	Trans.	E25	2BP	Mat	2SK663-P	FET	E26	3B	Mot	MMBT918	Trans.	E25
1L	Mot	MMBT6429	Trans.	E25	2BQ	Mat	2SK374-Q	FET	E25	3BG	Tos	2SA1325-GR	Trans.	E25
1LM	Rhm	2SC4103-M	Trans.	E26	2BQ	Mat	2SK663-Q	FET	E26	3BL	Tos	2SA1325-BL	Trans.	E25
1LN	Rhm	2SC4103-N	Trans.	E26	2BR	Sie,Phi	BC 849BR	Trans.	E25	3BR	Sie,Phi	BC 856BR	Trans.	E25
1LP	Rhm	2SC4103-P	Trans.	E26	2BR	Mat	2SK374-R	FET	E25	3CO	Tos	2SA1326-O	Trans.	E25
1LQ	Rhm	2SC4103-Q	Trans.	E26	2BR	Mat	2SK663-R	FET	E26	3CY	Tos	2SA1326-Y	Trans.	E25
1LR	Sie, Val	BC 848CR	Trans.	E25	2BS	Mat	2SK374-S	FET	E25	3D	Mot	MMBT H81	Trans.	E25
1M	Fer	FMMT-A13	Trans.	E25	2BS	Mat	2SK663-S	FET	E26	3D(p)	Phi	BC 856	Trans.	E25
1M	Mot	MMBT A13	Trans.	E25	2C	Fer	FMMT-A70	Trans.	E25	3E	Fer	FMMT-A42	Trans.	E25
1M	Itt	IMBT 3903	Trans.	E25	2C(p.s)	Sie,Phi	BC 849C	Trans.	E25	3E(p.s)	Sie,Phi	BC 857A	Trans.	E25
1M(p)	Phi	BC 848	Trans.	E25	2C	Mot, Sam	MMBT A70	Trans.	E25	3E	Mot	MMBT H10	Trans.	E25
1MP	Mat	2SJ84-P	FET	E25	2CR	Sie,Phi	BC 849CR	Trans.	E25	3ER	Sie,Phi	BC 857AR	Trans.	E25
1MQ	Mat	2SJ84-Q	FET	E25	2D	Mot	MMBT A92	Trans.	E25	3F(p.s)	Sie,Phi	BC 857B	Trans.	E25
1MR	Mat	2SJ84-R	FET	E25	2D(p)	Phi	BC 849	Trans.	E25	3F	Mot	MMBT6543	Trans.	E25
1N	Fer	FMMT-A14	Trans.	E25	2E	Fer	FMMT-A93	Trans.	E25	3FR	Sie,Phi	BC 857BR	Trans.	E25
1N	Mot	MMBT A14	Trans.	E25	2E	Mot	MMBT A93	Trans.	E25	3H(p)	Phi	BC 857	Trans.	E25
1N	Itt	IMBT 3904	Trans.	E25	2F	Fer	FMMT2907A	Trans.	E25	3J(p.s)	Sie,Phi	BC 858A	Trans.	E25
1OP	Mat	2SK198-P	FET	E25	2F(p.s)	Sie,Phi	BC 850B	Trans.	E25	3JR	Sie,Phi	BC 858AR	Trans.	E25
1OP	Mat	2SK662-P	FET	E26	2F	Mot	MMBT2907A	Trans.	E25	3K(p.s)	Sie,Phi	BC 858B	Trans.	E25
1OQ	Mat	2SK198-Q	FET	E25	2FR	Sie,Phi	BC 850BR	Trans.	E25	3KR	Sie,Phi	BC 858BR	Trans.	E25
1OQ	Mat	2SK662-Q	FET	E26	2FR	Mat	2SB792A-R	Trans.	E25	3L(p.s)	Sie,Phi	BC 858C	Trans.	E25

Code	Herst.	Typ	Art	Fig.	Code	Herst.	Typ	Art	Fig.	Code	Herst.	Typ	Art	Fig.
84	Sie	BAT 68-04	Diode	E25	AY	Tos	2SC2880-Y	Trans.	E28	CE	Sie,Val,Mot	BCX 69	Trans.	E28
85	Sie	BAT 68-05	Diode	E25	B1	Gen	D71G.05T1	Trans.	E28	CE	Say	2SC3649	Trans.	E28
86	Sie	BAT 68-06	Diode	E25	BA	Sie,Val,Mot	BCX 54	Trans.	E28	CE	Mit	2SA1364-E	Trans.	E28
087	Tho	SO 502R	Trans.	E25	BA	Say	2SB1118	Trans.	E28	CEC	Val	BC 869	Trans.	E28
091	Tho	SO 642R	Trans.	E25	BA	Hit	2SD1367-BA	Trans.	E28	CF	Sie,Val,Mot	BCX 69-10	Trans.	E28
702	Phi	2N7002	FET	E25	BA	Rhm	2SB1132	Trans.	E28	CF	Say	2SC3650	Trans.	E28
779	Aeg	S 779T	Trans.	E25	BB	Sie,Val,Mot	BCX 54-6	Trans.	E28	CG	Sie,Val,Mot	BCX 69-16	Trans.	E28
852	Aeg	S 852T	Trans.	E25	BB	Say	2SB1119	Trans.	E28	CG	Say	2SC3651	Trans.	E28
869	Aeg	S 869T	Trans.	E25	BB	Hit	2SD1367-BB	Trans.	E28	CGC	Phi	BC 869-10	Trans.	E28
879	Aeg	S 879T	Trans.	E25	BC	Sie,Val,Mot	BCX 54-10	Trans.	E28	CH	Sie,Val,Mot	BCX 69-25	Trans.	E28
					BC	Say	2SB1120	Trans.	E28	CH	Say	2SC4272	Trans.	E28
					BC	Hit	2SD1367-BC	Trans.	E28	CH	Hit	2SB1002-CH	Trans.	E28
					BC	Rhm	2SB1188	Trans.	E28	CHC	Phi	BC 869-16	Trans.	E28
					BD	Sie,Val,Mot	BCX 54-16	Trans.	E28	CI	Say	2SC4080	Trans.	E28
					BD	Say	2SB1121	Trans.	E28	CJ	Say	2SC4390	Trans.	E28
					BD	Rhm	2SB1189	Trans.	E28	CJ	Hit	2SB1002-CJ	Trans.	E28
					BE	Sie,Val,Mot	BCX 55	Trans.	E28	CK	Nip	2SD999-CK	Trans.	E28
					BE	Say	2SB1122	Trans.	E28	CK	Say	2SC4520	Trans.	E28
					BE	Mit	2SC3443-E	Trans.	E28	CL	Nip	2SD999-CL	Trans.	E28
					BF	Sie,Val,Mot	BCX 55-6	Trans.	E28	CL	Say	2SC4521	Trans.	E28
					BF	Say	2SB1123	Trans.	E28	CM	Nip	2SD999-CM	Trans.	E28
					BF	Mit	2SC3443-F	Trans.	E28	CM	Say	2SC4504	Trans.	E28
					BG	Sie,Val,Mot	BCX 55-10	Trans.	E28	CN	Say	2SC4548	Trans.	E28
					BG	Say	2SB1124	Trans.	E28	CO	Tos	2SC2881-O	Trans.	E28
					BG	Mit	3SC3443-G	Trans.	E28	CP	Mat	2SB767-P	Trans.	E28
					BH	Sie,Val,Mot	BCX 56	Trans.	E28	CQ	Mat	2SB767-Q	Trans.	E28
					BH	Say	2SB1125	Trans.	E28	CR	Mat	2SB767-R	Trans.	E28
					BH	Hit	2SB1001-BH	Trans.	E28	CS	Hit	2SD1870	Trans.	E28
					Bi	Say	2SB1126	Trans.	E28	CS	Mat	2SB767-S	Trans.	E28
					BJ	Sie,Val,Mot	BCX 56-6	Trans.	E28	CT	Hit	2SD1472	Trans.	E28
					BJ	Say	2SB1302	Trans.	E28	CY	Tos	2SC2881-Y	Trans.	E28
					BJ	Hit	2SB1001-BJ	Trans.	E28	CY	Hit	2SJ186	FET	E28
					BK	Sie,Val,Mot	BCX 56-10	Trans.	E28	DA	Sie,Val	BF 622	Trans.	E28
					BK	Say	2SB1323	Trans.	E28	DA	Say	2SD1618	Trans.	E28
					BL	Say	2SB1324	Trans.	E28	DA	Hit	2SD1418-DA	Trans.	E28
					BL	Phi	BCX 56-16	Trans.	E28	DA	Rhm	2SD1664	Trans.	E28
					BM	Say	2SB1325	Trans.	E28	DB	Sie,Val	BF 623	Trans.	E28
					BM	Phi	BCX 55-16	Trans.	E28	DB	Say	2SD1619	Trans.	E28
					BN	Say	2SB1394	Trans.	E28	DB	Hit	2SD1418-DB	Trans.	E28
					BO	Say	2SB1396	Trans.	E28	DB	Rhm	2SD1766	Trans.	E28
					BO	Tos	2SA1200-O	Trans.	E28	DC	Val	BF 620	Trans.	E28
					BP	Say	2SB1397	Trans.	E28	DC	Sie	BFN 20	Trans.	E28
					BQ	Mat	2SB766A-Q	Trans.	E28	DC	Say	2SD1620	Trans.	E28
					BR	Mat	2SB766A-R	Trans.	E28	DC	Mit	2SC3444-C	Trans.	E28
					BR1	Val	BSR 30	Trans.	E28	DC	Hit	2SD1418-DC	Trans.	E28
					BR2	Val	BSR 31	Trans.	E28	DC	Rhm	2SD1767	Trans.	E28
					BR3	Val	BSR 32	Trans.	E28	DD	Sie	BFN 16	Trans.	E28
					BR4	Val	BSR 33	Trans.	E28	DD	Say	2SD1621	Trans.	E28
					BS	Mat	2SB766A-S	Trans.	E28	DD	Mit	2SC3444-D	Trans.	E28
					BS1	Val	BST 60	Trans.	E28	DD	Hit	2SD1419-DD	Trans.	E28
					BS2	Val	BST 61	Trans.	E28	DE	Sie	BFN 18	Trans.	E28
					BS3	Val	BST 62	Trans.	E28	DE	Say	2SD1622	Trans.	E28
					BT	Hit	2SB1048	Trans.	E28	DE	Mit	2SC3444-E	Trans.	E28
					BT1	Val	BST 15	Trans.	E28	DE	Hit	2SD1419-DE	Trans.	E28
					BT2	Val	BST 16	Trans.	E28	DE	Rhm	2SD1834	Trans.	E28
					BU	Nip	2SD1005-BU	Trans.	E28	DF	Val	BF 621	Trans.	E28
					BV	Nip	2SD1005-BV	Trans.	E28	DF	Sie	BFN 21	Trans.	E28
					BW	Nip	2SD1005-BW	Trans.	E28	DF	Say	2SD1623	Trans.	E28
					BY	Tos	2SA1200-Y	Trans.	E28	DG	Sic	BFN 17	Trans.	E28
					BY	Hit	2SK1334	FET	E28	DG	Say	2SD1624	Trans.	E28
					CA	Sie,Val,Mot	BCX 68	Trans.	E28	DH	Sie	BFN 19	Trans.	E28
					CA	Say	2SC3645	Trans.	E28	DH	Say	2SD1625	Trans.	E28
					CA	Hit	2SD1368-CA	Trans.	E28	DH	Hit	2SB1025-DH	Trans.	E28
					CAC	Val	BC 868	Trans.	E28	DI	Say	2SD1626	Trans.	E28
					CB	Sie,Val,Mot	BCX 68-10	Trans.	E28	DJ	Say	2SD1627	Trans.	E28
					CB	Say	2SC3646	Trans.	E28	DJ	Hit	2SB1025-DJ	Trans.	E28
					CB	Hit	2SD1368-CB	Trans.	E28	DK	Nip	2SB798-DK	Trans.	E28
					CBC	Phi	BC 868-10	Trans.	E28	DK	Say	2SD1628	Trans.	E28
					CC	Sie,Val,Mot	BCX 68-16	Trans.	E28	DK	Hit	2SB1025-DK	Trans.	E28
					CC	Say	2SC3647	Trans.	E28	DL	Nip	2SB798-DL	Trans.	E28
					CC	Mit	2SA1364-C	Trans.	E28	DL	Say	2SD2099	Trans.	E28
					CC	Hit	2SD1368-CC	Trans.	E28	DL	Hit	2SB1026-DL	Trans.	E28
					COC	Phi	BC 868-16	Trans.	E28	DM	Nip	2SB798-DM	Trans.	E28
					CD	Sie,Val,Mot	BCX 68-25	Trans.	E28	DM	Say	2SD1998	Trans.	E28
					CD	Say	2SC3648	Trans.	E28	DM	Hit	2SB1026-DM	Trans.	E28
					CO	Mit	2SA1364-D	Trans.	E28	DN	Say	2SD1999	Trans.	E28
					CDC	Phi	BC 868-25	Trans.	E28	DO	Say	2SD1997	Trans.	E28

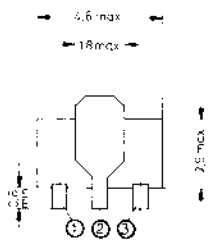

E28/SOT-89/TO-243

Code	Herst.	Typ	Art	Fig.	Code	Herst.	Typ	Art	Fig.	Code	Herst.	Typ	Art	Fig.	
121	Say	FC121	Trans.	E41	3	Hit	HVU306,306A	Diode	E43						
801	Say	FC801	Diode	E42	3A	Mat	MA30-A	Diode	E43						
802	Say	FC802	Diode	E42	3B	Mat	MA30-B	Diode	E43						
803	Say	FC803	Diode	E42	3C	Mat	MA30W-A	Diode	E43						
804	Say	FC804	Diode	E41	3D	Mat	MA30W-B	Diode	E43						
805	Say	FC805	Diode	E41	4	Hit	HVU350	Diode	E43						
806	Say	FC806	Diode	E41	4A	Mat	MA72	Diode	E39						
809	Say	FC809	Diode	E41	4B	Mat	MA73	Diode	E39						
903	Say	FC903	Diode	E42	4B	Mat	MA77	Diode	E43						
					4C	Mat	MA79	Diode	E43						
					4D	Mat	MA81	Diode	E43						
					5	Hit	1SV202	Diode	E39						
					5	Hit	HVR300	Diode	E39						
					5	Hit	HVU202	Diode	E43						
					5B	Mat	MA707	Diode	E39						
					5B	Mat	MA733	Diode	E43						
					6	Hit	HVU351	Diode	E43						
					6A	Mat	MA321	Diode	E39						
					6A	Mat	MA360	Diode	E43						
					6B	Mat	MA329	Diode	E39						
					6B	Mat	MA361	Diode	E43						
					6C	Mat	MA333	Diode	E39						
					6D	Mat	MA334	Diode	E39						
					6D	Mat	MA363	Diode	E43						
					6E	Mat	MA335	Diode	E39						
					6E	Mat	ME364	Diode	E43						
					6F	Mat	MA337	Diode	E39						
					6F	Mat	MA365	Diode	E43						
					6H	Mat	MA338	Diode	E39						
					6H	Mat	MA366	Diode	E43						
					6K	Mat	MA341	Diode	E39						
					6K	Mat	MA367	Diode	E43						
					6L	Mat	MA368	Diode	E43						
					6N	Mat	MA339	Diode	E39						
					6N	Mat	MA372	Diode	E43						
					6S	Mat	MA353	Diode	E39						
					6S	Mat	MA371	Diode	E43						
					6T	Mat	MA331	Diode	E43						
					6U	Mat	MA332	Diode	E43						
					6Y	Mat	MA355	Diode	E43						
					6Z	Mat	MA373	Diode	E43						
					7	Hit	HVU307	Diode	E43						
					7A	Mat	MA374	Diode	E43						
					7D	Mat	MA377	Diode	E43						
					8	Hit	HVU308	Diode	E43						
					9	Hit	HSU88	Diode	E43						



E43

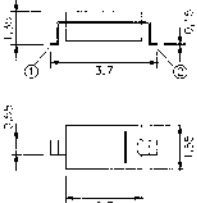

E39

A	Hit	HVU12	Diode	E43
C	Hit	HVR17	Diode	E39
C1	Tos	1SS352	Diode	E43
D	Hit	HVU187	Diode	E43
E	Hit	HVU17	Diode	E43
F	Hit	HVU352	Diode	E43
H	Hit	HVU354	Diode	E43
J	Hit	HVU357	Diode	E43
K	Hit	HVU315	Diode	E43
L	Hit	HVU356	Diode	E43
N	Hit	HVU316	Diode	E43
Q	Hit	HVU202A	Diode	E43
S	Hit	HVU358	Diode	E43
S2	Tos	1SS315	Diode	E43
S3	Tos	1SS357	Diode	E43
T1	Tos	1SV214	Diode	E43
T1	Tos	1SV153	Diode	E39
T2	Tos	1SV215	Diode	E43
T2	Tos	1SV161	Diode	E39
T3	Tos	1SV245	Diode	E43
T4	Tos	1SV216	Diode	E43
T5	Tos	1SV153A	Diode	E39
T6	Tos	1SV217	Diode	E43
T7	Tos	1SV230	Diode	E43
T7	Tos	1SV224	Diode	E39
T8	Tos	1SV229	Diode	E43
T9	Tos	1SV232	Diode	E43
T9	Tos	1SV227	Diode	E39
TA	Tos	1SV231	Diode	E43
TA	Tos	1SV226	Diode	E39
TB	Tos	1SV238	Diode	E43
TC	Tos	1SV239	Diode	E43
TY	Tos	1SS314	Diode	E43
0	Hit	HVU300,300A	Diode	E43
1	Hit	HVR187	Diode	E39
1	Hit	HSR101	Diode	E39
1A	Mat	MA110	Diode	E43
1B	Mat	MA111	Diode	E43
1C	Mat	MA112	Diode	E43
1D	Mat	MA113	Diode	E43
1E	Mat	MA114	Diode	E43
1F	Mat	MA115	Diode	E43
1H	Mat	MA116	Diode	E43
2	Hit	1SV200	Diode	E39
2	Hit	HVR100	Diode	E39
2	Hit	HVU200,200A	Diode	E43
2A	Mat	MA728	Diode	E43
2B	Mat	MA729	Diode	E43
2C	Mat	MA732	Diode	E43
3	Hit	HSU276,277	Diode	E43

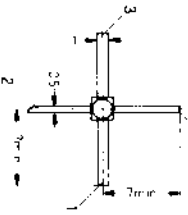
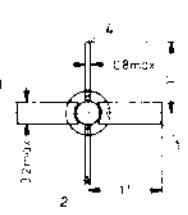
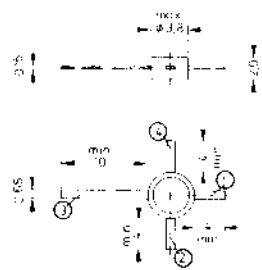
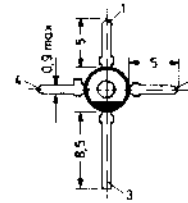
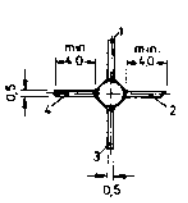
Code	Herst.	Typ	Art	Fig.	Code	Herst.	Typ	Art	Fig.	Code	Herst.	Typ	Art	Fig.	
															
		P17													
															
		P21													
															
		P22													
															
		P27/SOT-103													
															
		P30/SOT-173													
A	Hit	2SK1617	FET	P17	UG	Tos	3SK121	FET	P22						
A	Tos	2SK1619	FET	P17	UH	Tos	3SK150	FET	P22						
A1	Sie	CFY 10	FET	P17	UI	Tos	3SK152	FET	P22						
A1	Sie	CFY 19-18	FET	P30	UL	Tos	3SK159	FET	P22						
A2	Sie	CFY 10-22	FET	P30	UM	Tos	3SK198	FET	P22						
B	Hit	2SK1616	FET	P17	14B	Sie	BFR 14B	Trans.	P17						
B	Tos	2SK1325	FET	P17	14C	Sie	BFR 14C	Trans.	P21						
C	Mat	2SK649	FET	P30	28	Sie	BFQ 28	Trans.	P17						
C2	Val	BFQ 32C	Trans.	P30	57	Sie	BFQ 57	Trans.	P17						
C5	Sie	CFY 25-17	FET	P30	58	Sie	BFQ 58	Trans.	P17						
C6	Sie	CFY 25-20	FET	P30	59	Sie	BFQ 59	Trans.	P21						
C7	Sie	CFY 25-23	FET	P30	60	Sie	BFQ 60	Trans.	P17						
H	Hit	2SK1229	FET	P30	70	Sie	BFQ 70	Trans.	P30						
H	Mat	2SK1100	FET	P30	71	Sie	BFQ 71	Trans.	P30						
HA	Tos	2SC2804	Trans.	P27	72	Sie	BFQ 72	Trans.	P30						
HA	Sie	CFY 65-12	FET	P30	73S	Sie	BFQ 73S	Trans.	P30						
HB	Say	2SC3137	Trans.	P27	74	Sie	BFQ 74	Trans.	P30						
HB	Sie	CFY 65-14	FET	P30	75	Sie	BFQ 75	Trans.	P30						
HF	Tos	2SC2805	Trans.	P27	76	Sie	BFQ 76	Trans.	P30						
HG	Tos	2SC2806	Trans.	P27	82	Sie	BFQ 82	Trans.	P30						
HU	Tos	2SC3602	Trans.	P27	181	Sie	BFQ 181	Trans.	P30						
I	Mat	2SK1196	FET	P30	182	Sie	BFQ 182	Trans.	P30						
J	Mat	2SK1687	FET	P30	194	Sie	BFQ 194	Trans.	P30						
K	Mat	2SK1688	FET	P30	196	Sie	BFQ 196	Trans.	P30						
L	Mat	2SK1689	FET	P30	645	Sie	BFQ 645	Trans.	P30						
MA	Tos	2SC2876	Trans.	P27											
ME	Tos	2SC3302	Trans.	P27											
MH	Tos	2SC3608	Trans.	P27											
MN	Tos	2SC4319	Trans.	P22											
MO	Tos	2SC4323	Trans.	P22											
P1	Val	BFP 91A	Trans.	P30											
P6	Val	BFP 96	Trans.	P30											
PO	Val	BFP 90A	Trans.	P30											
Q3	Val	BFQ 33C	Trans.	P30											
Q6	Val	BFQ 66	Trans.	P30											
T	Hit	2SK1815	FET	P30											
UA	Tos	3SK101	FET	P22											
UC	Tos	3SK114	FET	P22											
UD	Tos	3SK115	FET	P22											
UE	Tos	3SK145	FET	P22											